

# Harnessing the wind of change.

Our cables supply societies with renewable energy.

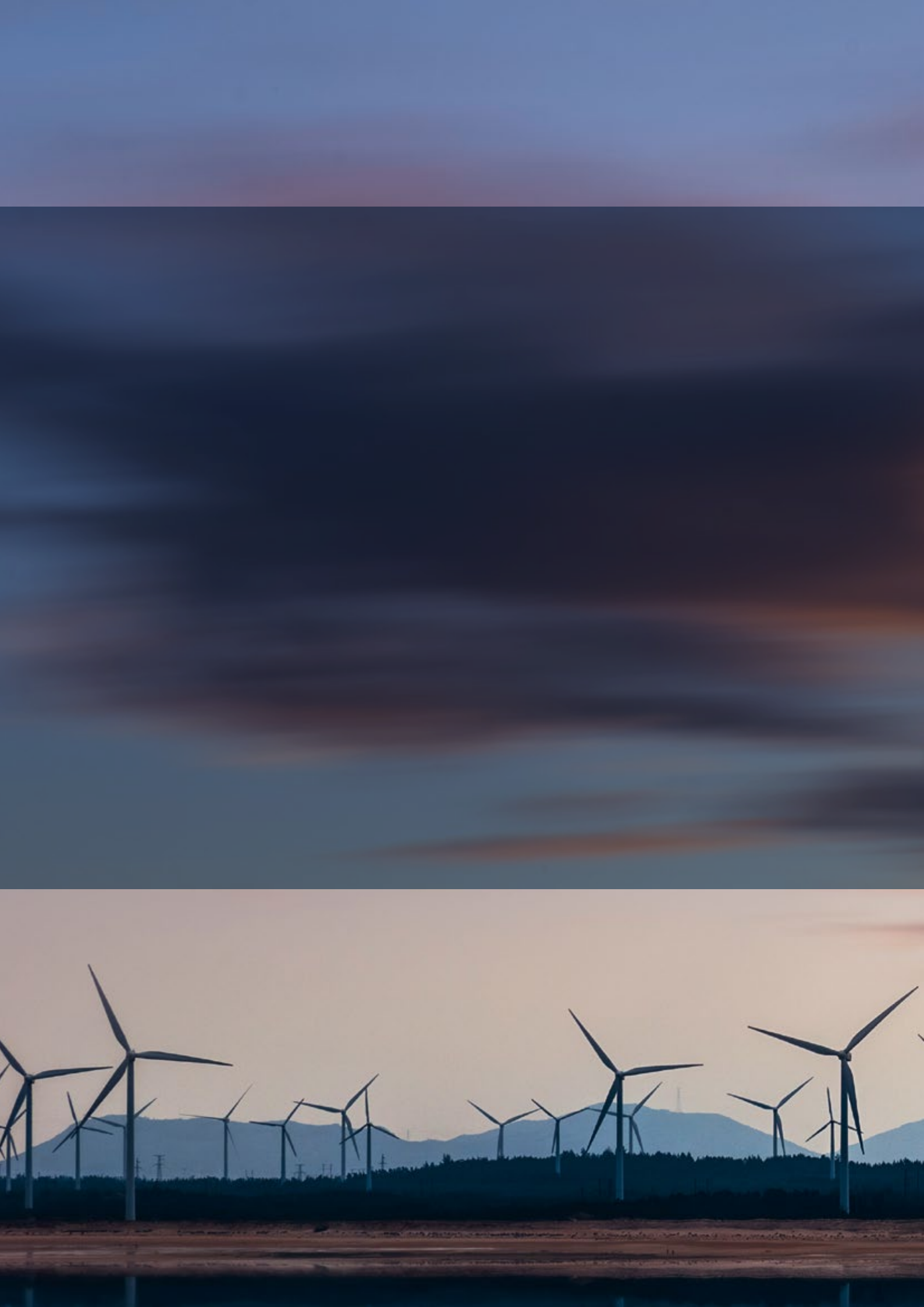



## Linking the future

As the worldwide leader in the cable industry, Prysmian Group believes in the effective, efficient and sustainable supply of energy and information as a primary driver in the development of communities.

With this in mind, we provide major global organisations in many industries with best-in-class cable solutions, based on state-of-the-art technology. Through three renowned commercial brands – Prysmian, Draka and General Cable – based in almost 50 countries, we're constantly close to our customers, enabling them to further develop the world's energy and telecoms infrastructures, and achieve sustainable, profitable growth.

In our energy business, we design, produce, distribute and install cables and systems for the transmission and distribution of power at low, medium, high and extra-high voltage.

In telecoms, the Group is a leading manufacturer of all types of copper and fibre cables, systems and accessories – covering voice, video and data transmission.

Drawing on over 130 years' experience and continuously investing in R&D, we apply excellence, understanding and integrity to everything we do, meeting and exceeding the precise needs of our customers across all continents, at the same time shaping the evolution of our industry.





## Contents

Linking the future	3
What links global expertise to the wheels of industry?	4
Wind turbines	5
What we offer	6
Our products and brands	7
TowerFlex®	8
WindFlex®	9
Felflex®-RC	10
Application overview	11
Wind turbines overview	12
Products	13
Product overview	14
Data sheets	16-68
Additional services/product range	69
PRY-CAM™ Grids	70
Offshore wind farms	71
A track record of success	72
Technical annex	73
Fire testing methods	74
Conductors	75
Electrical parameters	76
Drum handling	78



# What links global expertise to the wheels of industry?

High-performing cable solutions to keep the wheels of industry turning

On every continent, in applications that range from air and rail transport infrastructure to heavy duty and renewable industries such as on- and offshore wind turbines, Prysmian's specialist cable solutions sit at the heart of significant international projects; supporting the work of major customers, with high-performing, durable and safe technology.

As the world leader in cabling, we draw on global expertise and local presence to work in close proximity with our customers, delivering products and service platforms built on easy contact, bespoke solutions and effective supply chain, meeting their specialised requirements, to help them drive the wheels of industry and achieve sustainable growth and profitability.

# Wind turbines

## Linking sustainable ideas to real-world results

To meet an ever-growing need for power, the world is increasingly turning to renewable and sustainably-sourced energy.

In response to this demand, Prysmian's cables are helping wind turbine manufacturers around the globe to harness the true potential of this natural power source.

Always aware of our responsibility to the planet, we're constantly aiming to help renewable industry partners by delivering cables that benefit the future of both our world and their businesses.

And so, reflecting this commitment to sustainability, we offer premium quality products for wind turbines, proven in the field with long-lasting and trouble-free attributes

Our certified quality management with a worldwide focus ensures that product quality is always at the highest level, from the procurement and production processes, right through to the delivery process. With a focus on sustainable and environmentally friendly production processes, the Prysmian Group ensures that the fundamental principles of sustainable energy concepts are also implemented in its own company.

Our integrated management system complies with DIN EN ISO 9001, IRIS, ISO/TS 16949, KTA 1401, DIN EN ISO 14001, DIN EN ISO 50001 and OHSAS 18001. These are regularly monitored by independent experts.

As a world leader in special cables for wind turbines, we are able to manufacture products for the wind industry for all voltages or, if required, fully assembled cable sets in our German and international production sites:

- **Nacelle /Loop**

Special cables (optional halogen-free and flame retardant) with increased oil, heat and ozone resistance, as well as optimized torsion properties.

- **Tower**

Special cables (optional halogen-free and flame retardant) for fixed installation with copper or aluminium conductors with excellent installation properties.

- **Wind farm cabling**

From the low- and medium-voltage cables for the wind farm infrastructure, through to the high-voltage grid, we supply all cables for onshore and offshore applications.

In addition, we are able to supply cables as pre-assembled cable sets, as well as a service for fitting and commissioning or maintenance and turbine monitoring.



# What we offer

Our cables – used in wind turbine and tower operations – are hard at work across the renewables sector, supporting the work of turbine manufacturers, contractors and developers.

We provide a range of cables, accessories and services for all wind power generation applications – from the generator, to the grid (“One-stop-shop”).

Applying our many years of expertise and global capabilities, Prysmian offers one of the world’s most proven and comprehensive product ranges for wind power generators:

- **Medium Voltage cables**

For voltage classes of power from 6 kV up to 55 kV – we offer single and four core Medium Voltage flexible cables. They are optimized for torsion twist in the tower down to -40°C.

- **Low voltage cables**

For the connection from the generator to the transformer down the tower. Fully optimised for twisting at high and low temperatures in accordance to various standards.

- **Control cables**

Copper and fibre optic data cables for use in fixed and flexible installations. Designed for data transmission in low and high temperatures in accordance to various standards.

- **Customised cable set solutions**

Prysmian Group is specialized in the design, manufacture and delivery of customized cable sets with various terminations. Including low and medium voltage cables, data cables as well as fibre optic cables.

- **Specialty cables**

Different applications require different designs. For special application like EMC or hot oil we have specially designed cables.

- **Fibre optic**

We have a comprehensive and specialized program of pre-fabricated cable kits, customized solutions and accessories, for within or between towers, and grid connection

- **Click-Fit® Accessories & Components**

All products within the Click-Fit® range (including outdoor terminations, joints, Y (branch) joints and GIS/Transformer connectors) are based on the Click-Fit® Plug&Power concept for high voltage extruded cable accessories that enables optimum ease and speed of assembly, maximum reliability and maintenance-free operation, by ways of factory prepared (identical) cable ends. To minimize offshore installation times, cable ends can be prepared onshore and then installed and clamped inside the offshore turbine.





# Our products and brands

## **TOWERFLEX™**

Comprehensive low voltage cabling solutions with excellent handling and bending properties for fixed installation in wind turbines.

(For detailed information see page 8.)

## **WINDFLEX™ / TECWIND™**

Full range of low voltage and medium voltage cables, with high resistance to torsion, oil, ozone and flame. For flexible installation in wind turbines.

(For detailed information see page 9.)

## **FIBERCONNECT™**

Comprehensive and integrated fibre optical cabling solution for industrial Ethernet application in wind turbine towers.

## **CABLE SETS**

Wide range of low voltage and medium voltage pre-assembled and customized cable sets, for wind turbine and nacelle application.

## **PROTODUR / PROTOTHEN-X**

Low voltage PROTODUR cables and medium voltage PROTOTHEN-X cables for power distribution.

## **POWER TRANSMISSION**

High voltage and extra high voltage underground cable systems for power transmission.

## **ACCESSORIES**

Network components and accessories.

## **MV SUBMARINE CABLES**

Medium voltage submarine cables for inter-array and platform connection.

## **HVAC/HVDC EXPORT CABLES**

Submarine export cables with extruded insulation. HVAC up to 220 kV, HVDC up to 320 kV.

## **SERVICE**

Supporting the wind power industry through all realisations' phases from production and put in service of wind turbines to maintenance and monitoring.

## **PRY-CAM™ GRIDS**

Integrated and autonomous monitoring systems for partial discharge and temperature management of medium voltage components in wind turbines.

(For detailed information see page 70.)

## **FELTOFLEX®-RC**

Cables for use as flexible connection between offshore platforms as well as in switch-gears and transformers where very small bending radius and/or very low temperature is required.

(For detailed information see page 10.)

# TowerFlex®

## The cable solution for fixed installation in towers

TowerFlex® Global product family is comprised of two basic cable constructions with several subordinate cable types. TowerFlex® is specifically designed for fixed installation in towers to replace insulated power cables like NYY and bus bar systems. TowerFlex® program is extensive and include both copper and aluminium conductor versions. With lower weight the latter design allows for easier installation.

TowerFlex® is available with various approvals such as UL Recognition and UL Listing.

### Standards and approvals

It's important to understand the difference between a Recognized cable UL 758 and a Listed TC cable UL 1277 & UL 44.

The basis of TowerFlex®-S Global is standard IEC 60502-1, which has specified the construction, dimensions and test requirements.

Various options for approvals are available, such as UL Recognition (UL 758) and UL Listing (UL 2277, UL 1277 & UL 44).

Additional enhanced flame resistance according to IEC 60332-3-24 Category C, is also available. At Prysmian Group we listen to our customer's needs.

For that reason we produce TowerFlex®-S in different versions, depending on the wind turbine manufacturer's requirements for a UL Recognized vs UL Listed approval.

Just ask us, if you're in doubt!

Main points to consider when choosing which UL approval to use:

- Recognized cables can only be installed in machines. Fixed and flexible mounting allowed. Listed tray cables are allowed for horizontal as well as vertical installation in buildings.
- Flammability requirements are much less severe for a recognized cable. Whereas, Listed Tray Cables are required to resist large scale flame tests.
- Recognized cables can be lighter, due to different design requirements, that allow the use of thinner insulation and jackets. As listed tray cables are meant to be more "tough", thickness requirements are higher – so that the construction can withstand more severe flame tests.

### TowerFlex®-S Global

Low voltage cable concept applicable for fixed installation in nearly all sections of the wind turbine. Besides a standard version it's optionally available in halogen free, EMC-screened and extra flame retardant version.

### Range and rated voltage

TowerFlex®-S Global is available with copper or aluminium conductor, screened or unscreened, for rated voltage of 0.6/1 (1.2) kV and optionally 1.8/3 (3.6) kV. TowerFlex® single core cables are available from 1.5 mm<sup>2</sup> up to 630 mm<sup>2</sup>. Multi-core cables are available from 1.5 mm<sup>2</sup> up to 300 mm<sup>2</sup>.

### Pliability

The TowerFlex®-AS Global with aluminium conductor is extraordinary pliable and has excellent bending behaviour. This makes it as easy to install as the copper version.

### Streamlined version

TowerFlex®-S Global cables are designed with a thinner insulation and sheath thickness specified in IEC 60502-1. Due to their reduced weight they are easy to transport, store and install. The application of advanced compound materials means, that they adhere to the same stringent demands as our existing range of low voltage cables, without compromising safety.

### Conductor materials

TowerFlex®-S Global is a comprehensive cable program. You can choose between a standard conductor design employing copper or an aluminium version. With lower weight the latter design allows for easier installation.

### Design strengths

The TowerFlex®-S Global design is based on existing and proven WindFlex® technology, which offers an effective combination of both rubber insulation and sheathing. TowerFlex cables are robust due to a special high quality thermoset insulating and jacketing compound, a -40°C to +90°C temperature range, plus a special 120°C version.

### Oil and chemical resistance

TowerFlex®-S offers excellent resistance against mineral and synthetic gear oils, cooling fluids as well as hydraulic oils. We are committed to upholding this standard, by constantly testing the cable range against the latest industry oils.

### An economic alternative

TowerFlex®-S Global is more cost efficient to use for fixed installation than standard WindFlex®. The use in a fixed application allows us to design a cable that is less bulky, with lighter weight and smaller diameter. The results is an easier and less costly installation.



# WindFlex®

## The cable solution for flexible installation in towers

The WindFlex® product family is comprised of two basic cable constructions with each four subordinate cable types.

### WindFlex® cable portfolio

WindFlex® is an extensive low and medium voltage cable program applicable for flexible installation in wind turbines. Besides the standard version, available as options are halogen free, EMC-screened and extra flame retardant versions.

### Design strengths

The WindFlex® design is based on existing and well proven WindFlex® technology, which offers an effective combination of both rubber insulation and sheathing. WindFlex® cables are robust due to the special high quality thermosetting insulating and sheathing compounds used in their manufacture. They have a -40°C to +90°C temperature range as standard, however a special +120°C version is also available.

### Torsion capability

WindFlex® cables are tested for torsion during the toughest possible conditions. The test is carried out at -40°C and the cables are twisted 4 x 360° each way over 10 meters for a minimum of 5000 complete cycles, to simulate 20 years lifetime.

### Oil & chemical resistance

WindFlex® offers excellent resistance against mineral and synthetic gear oils, cooling fluids as well as hydraulic oils. We are committed to upholding this standard by constantly testing our cable range against new industry oils. By doing this we are confident that the cables we offer have passed the most extensive fluid resistance test program in the industry.

### Standards & approvals

The basis of WindFlex® is standard HD 22, which specifies the construction, dimensions and test requirements. Various options for approvals are available, such as UL Recognition (UL 758) and UL Listing (UL 1277 & UL 44). Additional enhanced flame resistance according to IEC 60332-3-24 category C, is also available.

### Conductor materials

WindFlex® is designed for maximum flexibility and the conductors are always made of class 5 annealed copper.

### An economic alternative

The WindFlex® program is the complete solution for wind turbine application. With a wide range of designs and approvals, Draka ensures that there is a tailor made solution for all wind applications.

With our wide Draka WindFlex® Global range of cables, we even ensure that one cable can be used throughout the world. The end result is simpler designs, simpler logistics and reduced costs.

### WindFlex® S (N)TSCGEHXOEU/3 36/60-69 (72,5) kV

These halogen-free high voltage cables are intended for use in wind turbines with medium mechanical effort in a temperature range from -40°C to +90°C. The cables can be installed free moveable, free hanging or fixed. For free hanging operation the cables are twistable. The cables are used for economic power transmission of large energy rates with high voltage.





# Felflex<sup>®</sup>-RC

## Ultra flexible high voltage cable system

Felflex<sup>®</sup>-RC cables are intended for use as flexible connection between offshore platforms as well as in switch-gears and transformers where very small bending radius and/or very low temperature is required, in dry or damp areas and outdoors. The flexibility of the cable allows operating equipment to be moved while running.

### Where flexibility counts

- Ultra bendable also in cold conditions.
- Extremely small bending radius.
- Easy handling.

### Cable design

- Felflex HV – 155 kV ultra-flexible cable system.
- High quality and fully qualified HV cable systems solution.
- Flexible Cu conductor up to 800 mm<sup>2</sup> (mobile use).
- HEPR insulation, high gradient design, super clean, extra flexible.
- Copper wires screen, 100% coverage.
- Outer EVA/EPDM sheath (HFFR), oil and ozone resistant (+UV).
- Optional external semicon cold strippable skin, HF rubber.
- Flame propagation (incl. semicon skin) IEC 60332-1/ IEC 60332-3-22/24.

### Main application

- Moveable interconnection cable between two platforms (topside – bridge).
- Design based on outstanding experience with MV crane festoon cables transferred to HV.
- Extremely low bending radius: 5x OD in fixed installation, 10x OD in mobile use.
- Moveable while running.
- Easy to lay.
- Projects delivered: Borwin 2, Helwin 2, Edvard Grieg, Ivar Aasen, Dolwin 3.

### Installation

- Dry installation, open air, with weather shields, free hanging in the interconnection portion
- Installation laying during winter/cold weather – Cold flexible min. operating temperatures during mobile use:
  - 50°C (FR IEC 60332-1-3)/
  - 25°C (FR IEC 60332-3-22/24).

### Benefits for the customer

- High quality and fully qualified flexible HV-cable system solution.
- Save construction/building cost (structure weights/space).
- Installation/laying during winter/cold weather.
- Tailor-made and wet design variants available.
- Full Turn-Key from Design to Monitoring.

### Proposed accessories

- Click-Fit connector
- Click-Fit joint

# Application overview

	Nacelle	Rotor/ pitch system	Generator/ Loop	Rectifier/ Loop	Trans- former/ Loop	Tower (fixed installa- tion)	Tower (flexible installa- tion)	Service lift	Base	Grid connec- tion	Offshore
TOWERFLEX™	●					●			●		
WINDFLEX™	●	●	●	●	●	●	●	●	●		
TECWIND™	●	●	●	●	●	●	●	●	●		
CABLE SETS	●	●	●	●	●	●	●	●	●		
PROTODUR/ PROTOTHEN-X										●	
HV + EHV UNDERGROUND CABLES										●	
MV SUBMARINE CABLES											●
HVAC/HVDC CABLES											●
PRY-CAM GRIDS™	●	●	●	●	●	●	●			●	●
FELTOFLEX®-RC	●				●	●	●		●		●

Further cables for special applications are available on request.



# Wind turbines overview

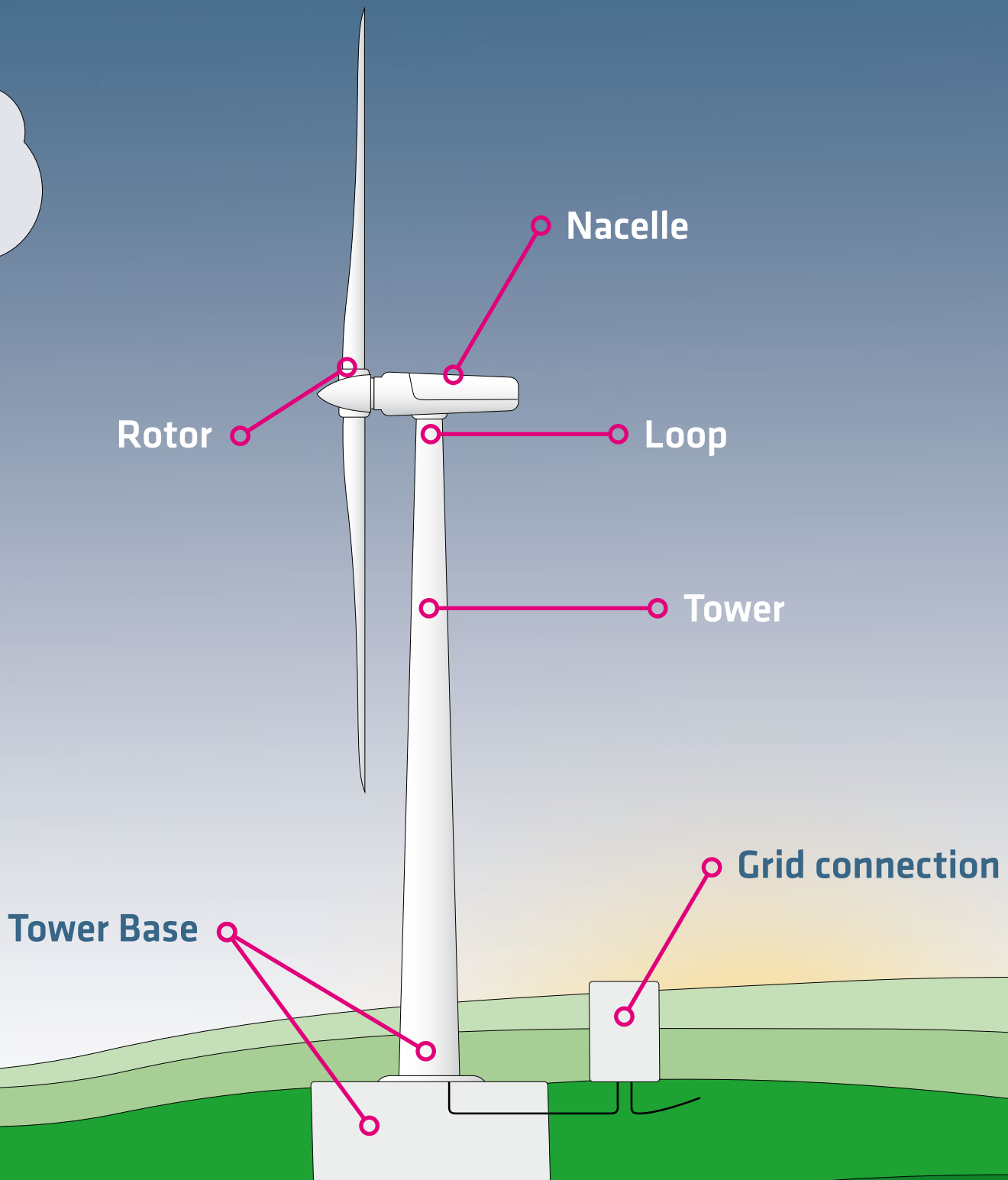

# Products

# Product overview

Wind		Product	Suitable for fix installation	Suitable for flexible installation	Datasheet page:
Nacelle	≤ 1 kV	TOWERFLEX-S GLOBAL EMC 3GDSGHOEU-K	X		16
		TOWERFLEX-S GLOBAL LSOH 3GSGHXOEU-K	X		17
		TOWERFLEX GLOBAL 120 LSOH 4GSGHXOEU-K	X		18
		TOWERFLEX GLOBAL EMC LSOH 3GCSGHXOEU-K	X		19
		TOWERFLEX-S GLOBAL 3GSGHOEU-K	X		20
		TOWERFLEX-AS GLOBAL EMC A3GCSGHOEU-R	X		21
		TOWERFLEX-AS GLOBAL A3GSGHOEU-R	X		22
		TOWERFLEX-AS GLOBAL LSOH A3GSGHXOEU-R	X		23
		WINDFLEX GLOBAL EMC S-3GDSHÖU	X	X	26-27
		WINDFLEX GLOBAL LSOH S-3GSHXOEU	X	X	28-29
		WINDFLEX GLOBAL EMC LSOH S-3GCSHXOEU	X	X	30-31
		WINDFLEX GLOBAL EMC S-3GCSHOEU	X	X	32-33
		WINDFLEX (GLOBAL) LSOH S-3GSHXOEU	X	X	34-35
		TOWERFLEX-A GLOBAL EMC A3GDGHOEU-R	X		24-25
		WINDFLEX GLOBAL EMC LSOH S-3GCSHXOEU	X	X	36-37
1,8/3 kV	TOWERFLEX GLOBAL EMC LSOH 3GCSGHXOEU-K	X		44	
	TOWERFLEX-AS GLOBAL A3GSGHOEU-R	X		45	
	TOWERFLEX-AS GLOBAL OR A3GSGHOEU-R	X		46	
	TOWERFLEX GLOBAL EMC 3GDSGHOEU-K	X		47	
	WINDFLEX (N)TMHXOEU	X	X	48-49	
12/20 kV	WINDFLEX LSOH (N)TMCHXOEU	X	X	52-53	
	WINDFLEX (N)TSCGEHXOEU	X	X	54-55	
	WINDFLEX (N)TSCGEHXOEU	X	X	56-57	
20/35 kV	WINDFLEX (N)TSCGEHXOEU	X	X	62-63	
66 kV	WINDFLEX (N)TSCGEHXOEU	X	X	64-65	
Loop	≤ 1 kV	WINDFLEX GLOBAL EMC S-3GDSHÖU	X	X	26-27
		WINDFLEX GLOBAL LSOH S-3GSHXOEU	X	X	28-29
		WINDFLEX GLOBAL EMC LSOH S-3GCSHXOEU	X	X	30-31
		WINDFLEX GLOBAL EMC S-3GCSHOEU	X	X	32-33
		WINDFLEX (GLOBAL) LSOH S-3GSHXOEU	X	X	34-35
	WINDFLEX GLOBAL EMC LSOH S-3GCSHXOEU	X	X	36-37	
	1,8/3 kV	WINDFLEX (N)TMHXOEU	X	X	48-49
	12/20 kV	WINDFLEX LSOH (N)TMCHXOEU	X	X	52-53
		WINDFLEX (N)TSCGEHXOEU	X	X	54-55
		WINDFLEX (N)TSCGEHXOEU	X	X	56-57
20/35 kV	WINDFLEX (N)TSCGEHXOEU	X	X	62-63	
66 kV	WINDFLEX (N)TSCGEHXOEU	X	X	64-65	
Tower	≤ 1 kV	TOWERFLEX-S GLOBAL EMC 3GDSGHOEU-K	X		16
		TOWERFLEX-S GLOBAL LSOH 3GSGHXOEU-K	X		17
		TOWERFLEX GLOBAL 120 LSOH 4GSGHXOEU-K	X		18
		TOWERFLEX GLOBAL EMC LSOH 3GCSGHXOEU-K	X		19
		TOWERFLEX-S GLOBAL 3GSGHOEU-K	X		20
		TOWERFLEX-AS GLOBAL EMC A3GCSGHOEU-R	X		21
		TOWERFLEX-AS GLOBAL A3GSGHOEU-R	X		22
		TOWERFLEX-AS GLOBAL LSOH A3GSGHXOEU-R	X		23
		WINDFLEX GLOBAL EMC S-3GDSHÖU	X	X	26-27
		WINDFLEX GLOBAL LSOH S-3GSHXOEU	X	X	28-29
		WINDFLEX GLOBAL EMC LSOH S-3GCSHXOEU	X	X	30-31
		WINDFLEX GLOBAL EMC S-3GCSHOEU	X	X	32-33
		WINDFLEX (GLOBAL) LSOH S-3GSHXOEU	X	X	34-35
		TOWERFLEX-A GLOBAL EMC A3GDGHOEU-R	X		24-25
		WINDFLEX GLOBAL EMC LSOH S-3GCSHXOEU	X	X	36-37



Wind		Product	Suitable for fix installation	Suitable for flexible installation	Datasheet page:
Tower	1,8/3 kV	TOWERFLEX GLOBAL EMC LSOH 3GCSGHXOEU-K	X		44
		TOWERFLEX-AS GLOBAL A3GSGHOEU-R	X		45
		TOWERFLEX-AS GLOBAL OR A3GSGHOEU-R	X		46
		TOWERFLEX GLOBAL EMC 3GDSGHOEU-K	X		47
		WINDFLEX (N)TMHXOEU	X	X	48-49
	12/20 kV	WINDFLEX LSOH (N)TMCHXOEU	X	X	52-53
		WINDFLEX (N)TSCGEHXOEU	X	X	54-55
		WINDFLEX (N)TSCGEHXOEU	X	X	56-57
	20/35 kV	WINDFLEX (N)TSCGEHXOEU	X	X	62-63
	66 kV	WINDFLEX (N)TSCGEHXOEU	X	X	64-65
Tower Base	≤ 1 kV	TOWERFLEX-S GLOBAL EMC 3GDSGHOEU-K	X		16
		TOWERFLEX-S GLOBAL LSOH 3GSGHXOEU-K	X		17
		TOWERFLEX GLOBAL 120 LSOH 4GSGHXOEU-K	X		18
		TOWERFLEX GLOBAL EMC LSOH 3GCSGHXOEU-K	X		19
		TOWERFLEX-S GLOBAL 3GSGHOEU-K	X		20
		TOWERFLEX-AS GLOBAL EMC A3GCSGHOEU-R	X		21
		TOWERFLEX-AS GLOBAL A3GSGHOEU-R	X		22
		TOWERFLEX-AS GLOBAL LSOH A3GSGHXOEU-R	X		23
		WINDFLEX GLOBAL EMC S-3GDSHÖU	X	X	26-27
		WINDFLEX GLOBAL LSOH S-3GSHXOEU	X	X	28-29
		WINDFLEX GLOBAL EMC LSOH S-3GCSHXOEU	X	X	30-31
		WINDFLEX GLOBAL EMC S-3GCSHOEU	X	X	32-33
		WINDFLEX (GLOBAL) LSOH S-3GSHXOEU	X	X	34-35
		TOWERFLEX-A GLOBAL EMC A3GDGHOEU-R	X		24-25
	WINDFLEX GLOBAL EMC LSOH S-3GCSHXOEU	X	X	36-37	
	1,8/3 kV	TOWERFLEX GLOBAL EMC LSOH 3GCSGHXOEU-K	X		44
		TOWERFLEX-AS GLOBAL A3GSGHOEU-R	X		45
		TOWERFLEX-AS GLOBAL OR A3GSGHOEU-R	X		46
		TOWERFLEX GLOBAL EMC 3GDSGHOEU-K	X		47
		WINDFLEX (N)TMHXOEU	X	X	48-49
	12/20 kV	WINDFLEX LSOH (N)TMCHXOEU	X	X	52-53
		WINDFLEX (N)TSCGEHXOEU	X	X	54-55
		WINDFLEX (N)TSCGEHXOEU	X	X	56-57
20/35 kV	WINDFLEX (N)TSCGEHXOEU	X	X	62-63	
66 kV	WINDFLEX (N)TSCGEHXOEU	X	X	64-65	
Rotor/pitch system	≤ 1 kV	WINDFLEX GLOBAL EMC S-3GDSHÖU	X	X	26-27
		WINDFLEX GLOBAL LSOH S-3GSHXOEU	X	X	28-29
		WINDFLEX GLOBAL EMC LSOH S-3GCSHXOEU	X	X	30-31
		WINDFLEX GLOBAL EMC S-3GCSHOEU	X	X	32-33
		WINDFLEX (GLOBAL) LSOH S-3GSHXOEU	X	X	34-35
WINDFLEX GLOBAL EMC LSOH S-3GCSHXOEU	X	X	36-37		
Grid connection	≤ 1 kV	PROTODUR NYY 0,6/1 kV CPR Eca	X		38-40
		PROTODUR NAYY 0,6/1 kV CPR Eca	X		42-43
	6/10 kV	PROTOTHEN-X NA2XS(FL)2Y 6/10 kV CPR Fca	X		50-51
	12/20 kV	PROTOTHEN-X NA2XS(FL)2Y 12/20 kV CPR Fca	X		58-59
	18/30 kV	PROTOTHEN-X NA2XS(FL)2Y 18/30 kV CPR Fca	X		60-61
66 kV	FELTOFLEX-RC (N)TMCHXOEU	X	X	66-67	

## TOWERFLEX-S GLOBAL EMC 3GDSGHOEU-K 0,6/1 kV



### Application

These cables are intended for use in wind turbines, suitable for fixed installation at medium mechanical stress. For system design planning, dimensioning of conductor cross-section, current-carrying capacities and reference methods of installation, as well as applicable correction factors, the specific data of IEC 60364-5-52 have to be considered.

### Global data

Brand	TOWERFLEX-S GLOBAL EMC
Type designation	3GDSGHOEU-K
Standard	Based on IEC 60502-1

### Design features

Conductor	Copper bare, stranded wire class 5 acc. to IEC 60228 / DIN EN 60228
Insulation	Rubber, compound type HEPR acc. to IEC 60502-1
Screen	Spinning of tinned copper wires Covering > 90 % (Option: Braid of tinned copper wires)
Outer sheath	Rubber, compound type 5GM3 acc. to DIN VDE 0207 Part 21
Outer sheath colour	Black

### Electrical parameters

Rated voltage	0.6/1 kV (600/1000V)
Max. permissible operating voltage AC	0.7/1.2 kV
Max. permissible operating voltage DC	0.9/1.8 kV

### Chemical parameters

Flame propagation	DIN EN 60332-1-2
Resistance to oil	DIN EN 60811-404
UV-resistance	Cable is UV-resistant
Ozone resistance	DIN EN 60811-403 IEC 60811-403

### Thermal parameters

Max. permissible temperature at conductor	90 °C
Max. short circuit temperature of the conductor	250 °C
Ambient temperature for fix installation min.	-40 °C

### Mechanical parameters

Max. tensile load on the conductor	15 N/mm <sup>2</sup>
Min. bending radius	Acc. to DIN VDE 0298 part 3

Number of cores x cross section	Part number	Conductor diameter max. mm	Insulation thickness nom. mm	Outer Sheath Thickness nom. mm	Outer diameter min. mm	Outer diameter max. mm	Weight (approx.) kg/km	Conductor resistance at 20°C max. Ω/km	AC resistance at max. conductor temp. Ω/km	Nominal operating capacitance μF/km	Inductive Reactance (at 50Hz) Ω/km	Current carrying capacity (1) A	Short Circuit Current (conductor) max. (1s) kA
1x120	20196513	14.8	1.2	1.6	21.2	22.7	1370	0.161	0.2	0.75	0.095	383	17.16
1x185	20195236	17.7	1.6	1.8	25.5	27	2040	0.106	0.14	0.74	0.094	510	26.46
1x240	20132466	20.3	1.7	1.8	28	30	2500	0.0801	0.1021	1.044	0.081	541	34.3
1x300	20132467	22.7	1.8	1.8	30.5	32.5	3130	0.0641	0.0817	1.104	0.08	612	42.9

## TOWERFLEX-S GLOBAL LSOH 3GSGHXOEU-K 0,6/1 kV



### Application

These cables are intended for fixed installations in wind turbines in cases where improved flexibility and very good bending behaviour is required.

### Global data

Brand	TOWERFLEX-S GLOBAL LSOH
Type designation	3GSGHXOEU-K
Standard	Based on IEC 60502-1

### Design features

Conductor	Copper bare, stranded wire class 5 acc. to IEC 60228 / DIN EN 60228
Insulation	Rubber, compound type HEPR acc. to IEC 60502-1
Core identification	acc. to HD 308
Inner sheath	Rubber, compound type GM1b acc. to DIN VDE 0207 part 21
Outer sheath	Rubber, compound type HXM1 acc. to DIN VDE 0266
Outer sheath colour	Black

### Electrical parameters

Rated voltage	0.6/1 kV (600/1000V)
---------------	----------------------

### Chemical parameters

Smoke emission	DIN EN 61034-2
Flame propagation	DIN EN 60332-1-2
Resistance to oil	DIN EN 60811-404
UV-resistance	Cable is UV-resistant
Ozone resistance	DIN EN 60811-403 IEC 60811-403

### Thermal parameters

Max. permissible temperature at conductor	90 °C
Max. short circuit temperature of the conductor	250 °C
Ambient temperature for fix installation min.	-40 °C

### Mechanical parameters

Max. tensile load on the conductor	15 N/mm <sup>2</sup>
Min. bending radius	Acc. to DIN VDE 0298 part 3

Number of cores x cross section	Part number	Conductor diameter max. mm	Insulation thickness nom. mm	Outer Sheath Thickness nom. mm	Outer diameter min. mm	Outer diameter max. mm	Bending radius fixed min. mm	Weight (approx.) kg/km	Permissible tensile force max. N	Conductor resistance at 20°C max. Ω/km	AC resistance at max. conductor temp. Ω/km	Inductive Reactance (at 50Hz) Ω/km	Current carrying capacity (1) A	Short Circuit Current (conductor) kA
1x185	20079818	17.7	1.6	1.7	23	26	104	1880	2775	0.106	0.135	0.079	461	26.4
1x240		20.2	1.7	1.8	26	29	116	2410	3600	0.0801	0.1021	0.078	541	34.3
1x300	20132464	22.7	1.8	1.8	28	31	124	2930	4500	0.0641	0.0817		612	42.9
3x70		11.2	1.1	2	33	36	148	2765	3150	0.272	0.346	0.071	250	10
3x240	20131647	20.2	1.7	2.7	58	64	256	8540	10800	0.0801	0.1021	0.069	541	34.3



## TOWERFLEX GLOBAL 120 LSOH 4GSGHXOEU-K 0,6/1 kV



### Application

These cables are intended for fixed installations in wind turbines. The maximum conductor temperature is + 110 °C at regular conditions. A temporary increase up to + 120 °C is permitted. Contact by hand should be avoided when this cable is used in high temperature installation.

### Global data

Brand	TOWERFLEX GLOBAL 120 LSOH
Type designation	4GSGHXOEU-K
Standard	Based on IEC 60502-1

### Design features

Conductor	Copper, bare (or tinned), fine wire class 5 acc. to IEC 60228 / DIN EN 60228
Insulation	Rubber, compound type EI3 acc. to DIN VDE 0282 part 1
Outer sheath	Rubber, compound type EM4 acc. to DIN VDE 0282 part 1
Outer sheath colour	Black

### Electrical parameters

Rated voltage	0.6/1 kV (600/1000V)
---------------	----------------------

### Chemical parameters

Flame propagation	DIN EN 60332-1-2
Resistance to oil	DIN EN 60811-404
UV-resistance	Cable is UV-resistant
Ozone resistance	DIN EN 60811-403 IEC 60811-403

### Thermal parameters

Max. permissible temperature at conductor	110 °C
Max. short circuit temperature of the conductor	250 °C
Ambient temperature for fix installation min.	-40 °C

### Mechanical parameters

Max. tensile load on the conductor	15 N/mm <sup>2</sup>
Min. bending radius	Acc. to DIN VDE 0298 part 3

Number of cores x cross section	Part number	Conductor diameter max. mm	Insulation thickness nom. mm	Outer Sheath Thickness nom. mm	Outer diameter min. mm	Outer diameter max. mm	Bending radius fixed min. mm	Weight (approx.) kg/km	Permissible tensile force max. N	Conductor resistance at 20°C max. Ω/km	AC resistance at max. conductor temp. Ω/km	Inductive Reactance (at 50Hz) Ω/km	Current carrying capacity (1) A	Short Circuit Current (conductor) kA
1x50		9.1	1.4	1.4	13.5	15.5	62	564	750	0.386	0.523	0.09	207	6.6
1x70		11.2	1.4	1.5	15	18	72	786	1050	0.272	0.368	0.086	268	9.2
1x95		12.8	1.6	1.5	17	20	80	1023	1425	0.206	0.279	0.084	328	12
1x120		14.6	1.6	1.6	19	22	88	1280	1800	0.161	0.218	0.083	383	15.2
1x150		16.1	1.8	1.6	21	24	96	1555	2250	0.129	0.175	0.082	444	19.8
1x185		17.9	2	1.7	24	27	108	1906	2775	0.106	0.143	0.081	510	24.4
1x240		20.4	2.2	1.8	27	30	120	2463	3600	0.0801	0.1084	0.08	607	31.6
1x300		22.8	2.4	1.9	30	33	132	3054	4500	0.0641	0.0868	0.08	703	39.6
1x400		26.2	2.6	2	34	38	152	4010	6000	0.0486	0.0658	0.078	823	52.8
1x500	20220568		2.6	2	38	42	168	4870	7500					
1x630	20220569		2.6	2	41	45	180	6380	9450					

## TOWERFLEX GLOBAL EMC LSOH 3GCSGHXOEU-K 0,6/1 kV



### Application

These cables are intended for fixed installations in wind turbines in cases where improved flexibility and very good bending behaviour is required.

### Global data

Brand	TOWERFLEX GLOBAL EMC LSOH
Type designation	3GCSGHXOEU-K
Standard	Based on IEC 60502-1

### Design features

Conductor	Copper bare, stranded wire class 5 acc. to IEC 60228 / DIN EN 60228
Insulation	Rubber, compound type EPR acc. to IEC 60502-1
Core identification	acc. to HD 308
Inner sheath	Rubber, compound type GM1b, acc. to DIN VDE 0207 part 21
Screen over inner sheath	Braid of tinned copper wires, optical covering > 85 % Lapping with rubberized textile tape
Outer sheath	Rubber, compound type HXM1 acc. to DIN VDE 0266
Outer sheath colour	Black

### Electrical parameters

Rated voltage	0.6/1 kV (600/1000V)
---------------	----------------------

### Chemical parameters

Smoke emission	DIN EN 61034-2
Flame propagation	DIN EN 60332-1-2
Resistance to oil	DIN EN 60811-404
UV-resistance	Cable is UV-resistant
Ozone resistance	DIN EN 60811-403 IEC 60811-403

### Thermal parameters

Max. permissible temperature at conductor	90 °C
Max. short circuit temperature of the conductor	250 °C
Ambient temperature for fix installation min.	-40 °C

### Mechanical parameters

Max. tensile load on the conductor	15 N/mm <sup>2</sup>
Min. bending radius	Acc. to DIN VDE 0298 part 3

Number of cores x cross section	Part number	Conductor diameter max. mm	Insulation thickness nom. mm	Outer Sheath Thickness nom. mm	Outer diameter min. mm	Outer diameter max. mm	Weight (approx.) kg/km	Conductor resistance at 20°C max. Ω/km	AC resistance at max. conductor temp. Ω/km	Inductive Reactance (at 50Hz) Ω/km	Inductive Reactance (at 60Hz) Ω/km	Current carrying capacity (1) A	Short Circuit Current (conductor) max. (1s) kA
2x35/16	20076200	7.5	1.2	1.8	26	29	1440	0.554	0.706	0.077	0.093	185	5.01

## TOWERFLEX-S GLOBAL 3GSGHOEU-K 0,6/1 kV



### Application

These cables are intended for use in wind turbines, suitable for fixed installation at medium mechanical stress.

### Global data

Brand	TOWERFLEX-S GLOBAL
Type designation	3GSGHOEU-K
Standard	Based on IEC 60502-1

### Design features

Conductor	Copper bare, stranded wire class 5 acc. to IEC 60228 / DIN EN 60228
Insulation	Rubber, compound type SE1 acc. to IEC 60502-1
Outer sheath	Rubber, compound type 5GM3 acc. to DIN VDE 0207 Part 21
Outer sheath colour	Black

### Electrical parameters

Rated voltage	0.6/1 kV (600/1000V)
---------------	----------------------

### Chemical parameters

Flame propagation	DIN EN 60332-1-2
Resistance to oil	DIN EN 60811-404
UV-resistance	Cable is UV-resistant
Ozone resistance	DIN EN 60811-403 IEC 60811-403

### Thermal parameters

Max. permissible temperature at conductor	90 °C
Max. short circuit temperature of the conductor	250 °C
Ambient temperature for fix installation min.	-40 °C

### Mechanical parameters

Max. tensile load on the conductor	15 N/mm <sup>2</sup>
Min. bending radius	Acc. to DIN VDE 0298 part 3

Number of cores x cross section	Part number	Conductor diameter max. mm	Insulation thickness nom. mm	Outer Sheath Thickness nom. mm	Outer diameter min. mm	Outer diameter max. mm	Weight (approx.) kg/km	Conductor resistance at 20°C max. Ω/km	AC resistance at max. conductor temp. Ω/km	Nominal operating capacitance μF/km	Inductive Reactance (at 50Hz) Ω/km	Current carrying capacity (1) A	Short Circuit Current (conductor) max. (1s) kA
1x120	20195233	14.4	1.2	1.3	19	20.66	1230	0.161			0.073	383	17.16
1x185	20194703	17.7	1.6	1.7	23	26	1890	0.106			0.073	510	26.46
1x240	20132463	20.2	1.7	1.8	26.8	27.8	2330	0.0801	0.102	0.697	0.078	541	34.3
1x300	20099806	22.7	1.8	1.8	28	31	2920	0.0641	0.082	0.749	0.077	612	42.9
1x400	20099807	25.5	2	1.9	32	35	3810	0.0486	0.062	0.77	0.076	681	57.2

## TOWERFLEX-AS GLOBAL EMC A3GCSGHOEU-R 0,6/1 kV



### Application

These cables are intended for use in wind turbines, suitable for fixed installation at medium mechanical stress. For system design planning, dimensioning of conductor cross-section, current-carrying capacities and reference methods of installation, as well as applicable correction factors, the specific data of IEC 60364-5-52 have to be considered.

### Global data

Brand	TOWERFLEX-AS GLOBAL EMC
Type designation	A3GCSGHOEU-R
Standard	AS/NZS 1125:2001 Based on IEC 60502-1

### Design features

Conductor	Aluminium, stranded wire class 2, soft annealed, acc. to IEC 60228 / DIN EN 60228
Insulation	Rubber, compound type HEPR acc. to IEC 60502-1
Screen over inner sheath	Spiral wrap of tinned copper wires Covering > 90 % (Option: Braid of tinned copper wires)
Outer sheath	Rubber, compound type 5GM3 acc. to DIN VDE 0207 Part 21
Outer sheath colour	Black

### Electrical parameters

Rated voltage	0.6/1 kV (600/1000V)
---------------	----------------------

### Chemical parameters

Flame propagation	DIN EN 60332-1-2
Resistance to oil	DIN EN 60811-404
UV-resistance	Cable is UV-resistant
Ozone resistance	DIN EN 60811-403 IEC 60811-403

### Thermal parameters

Max. permissible temperature at conductor	90 °C
Max. short circuit temperature of the conductor	250 °C
Ambient temperature for fix installation min.	-40 °C

### Mechanical parameters

Max. tensile load on the conductor	30 N/mm <sup>2</sup>
Min. bending radius	Acc. to DIN VDE 0298 part 3

Number of cores x cross section	Part number	Conductor diameter max. mm	Insulation thickness nom. mm	Outer Sheath Thickness nom. mm	Outer diameter min. mm	Outer diameter max. mm	Weight (approx.) kg/km	Conductor resistance at 20°C max. Ω/km	AC resistance at max. conductor temp. Ω/km	Nominal operating capacitance μF/km	Inductive Reactance (at 50Hz) Ω/km	Current carrying capacity (1) A	Short Circuit Current (conductor) max. (1s) kA
1x185 /10	20132470	16	1.6	1.7	23	25	910	0.164	0.21	0.885	0.086	395	17.4
1x240 /10	20135375	18.1	1.7	1.8	25.5	27.5	1130	0.125	0.16	0.939	0.084	471	22.7
1x300 /16	20135376	21	1.8	1.8	28.5	30.5	1390	0.1	0.128	1.019	0.082	547	28.3
1x400 /16	20133541	23.7	2	2	32	34	1730	0.078	0.1	1.042	0.081	663	37.6
1x500 /16	20133542	26.5	2.2	2.1	35.5	37.5	2160	0.061	0.078	1.064	0.08	770	47

## TOWERFLEX-AS GLOBAL A3GSGHOEU-R 0,6/1 kV



### Application

These cables are intended for use in wind turbines, suitable for fixed installation at medium mechanical stress.

### Global data

Brand	TOWERFLEX-AS GLOBAL
Type designation	A3GSGHOEU-R
Standard	AS/NZS 1125:2001 Based on IEC 60502-1

### Design features

Conductor	Aluminium, stranded wire class 2, soft annealed, acc. to IEC 60228 / DIN EN 60228
Insulation	Rubber, compound type HEPR acc. to IEC 60502-1
Outer sheath	Rubber, compound type 5GM3 acc. to DIN VDE 0207 Part 21
Outer sheath colour	Black

### Electrical parameters

Rated voltage	0.6/1 kV (600/1000V)
---------------	----------------------

### Chemical parameters

Flame propagation	DIN EN 60332-1-2
Resistance to oil	DIN EN 60811-404
UV-resistance	Cable is UV-resistant
Ozone resistance	DIN EN 60811-403 IEC 60811-403

### Thermal parameters

Max. permissible temperature at conductor	90 °C
Max. short circuit temperature of the conductor	250 °C
Ambient temperature for fix installation min.	-40 °C

### Mechanical parameters

Max. tensile load on the conductor	30 N/mm <sup>2</sup>
Min. bending radius	Acc. to DIN VDE 0298 part 3

Number of cores x cross section	Part number	Conductor diameter max. mm	Insulation thickness nom. mm	Outer Sheath Thickness nom. mm	Outer diameter min. mm	Outer diameter max. mm	Bending radius fixed min. mm	Weight (approx.) kg/km	Permissible tensile force max. N	Conductor resistance at 20°C max. Ω/km	AC resistance at max. conductor temp. Ω/km	Inductive Reactance (at 50Hz) Ω/km	Current carrying capacity (1) A	Short Circuit Current (conductor) kA
1x50		7.9	1	1.4	11.5	14.5	58	245	1500	0.64	0.817	0.09	159	4.7
1x70		9.9	1.1	1.5	13.5	16.5	66	350	2100	0.443	0.565	0.086	206	6.6
1x95		11.3	1.1	1.5	15	18	72	435	2850	0.32	0.408	0.083	253	8.9
1x120		12.6	1.2	1.6	17	20	80	543	3600	0.253	0.323	0.083	296	11.3
1x150		14.3	1.4	1.6	18.5	21.5	86	638	4500	0.206	0.263	0.082	343	14.1
1x185		16	1.6	1.7	21	24	96	812	5550	0.164	0.209	0.081	395	17.4
1x240		18.1	1.7	1.8	24	27	108	1008	7200	0.125	0.159	0.08	471	22.7
1x300	20057779	21	1.8	1.8	27.5	30.5	122	1200	9000	0.1	0.128	0.078	547	28.3
1x400	20099810	23.8	2	2	30	33	132	1600	12000	0.0778	0.099	0.078	663	37.6
1x500	20098183	26.5	2.2	2.1	33	37	148	1930	15000	0.0605	0.077	0.077	770	47
1x630	20220567	29.8	2.4	2.2	37	41	164	2400	18900	0.0469			886	59.2



## TOWERFLEX-AS GLOBAL LSOH A3GSGHXOEU-R 0,6/1 kV



### Application

These cables are intended for use in wind turbines, suitable for fixed installation at medium mechanical stress.

### Global data

Brand	TOWERFLEX-AS GLOBAL LSOH
Type designation	A3GSGHXOEU-R
Standard	Based on IEC 60502-1

### Design features

Conductor	Aluminium, stranded wire class 2, soft annealed, acc. to IEC 60228 / DIN EN 60228
Insulation	Rubber, compound type HEPR acc. to IEC 60502-1
Outer sheath	Rubber, compound type HXM1 acc. to DIN VDE 0266
Outer sheath colour	Black

### Electrical parameters

Rated voltage	0.6/1 kV (600/1000V)
Max. permissible operating voltage AC	0.7/1.2 kV
Max. permissible operating voltage DC	0.9/1.8 kV

### Chemical parameters

Smoke emission	DIN EN 61034-2
Flame propagation	IEC 60332-1-2 up to 150mm <sup>2</sup> IEC 60332-3-24 from 185mm <sup>2</sup>
Resistance to oil	DIN EN 60811-404
UV-resistance	Cable is UV-resistant
Ozone resistance	DIN EN 60811-403 IEC 60811-403

### Thermal parameters

Max. permissible temperature at conductor	90 °C
Max. short circuit temperature of the conductor	250 °C
Ambient temperature for fix installation min.	-40 °C

### Mechanical parameters

Max. tensile load on the conductor	30 N/mm <sup>2</sup>
Min. bending radius	Acc. to DIN VDE 0298 part 3

Number of cores x cross section	Part number	Conductor diameter max. mm	Insulation thickness nom. mm	Outer Sheath Thickness nom. mm	Outer diameter min. mm	Outer diameter max. mm	Bending radius fixed min. mm	Weight (approx.) kg/km	Permissible tensile force max. N	Conductor resistance at 20°C max. Ω/km	AC resistance at max. conductor temp. Ω/km	Inductive Reactance (at 50Hz) Ω/km	Current carrying capacity (1) A	Short Circuit Current (conductor) kA
1x50		7.9	1	1.4	11.5	14.5	58	243	1500	0.64	0.817	0.09	159	4.7
1x70		9.9	1.1	1.5	13.5	16.5	66	347	2100	0.443	0.565	0.086	206	6.6
1x95		11.3	1.1	1.5	15	18	72	429	2850	0.32	0.408	0.083	253	8.9
1x120	20135383	12.6	1.2	1.6	17	20	80	540	3600	0.253	0.323	0.083	296	11.3
1x150		14.3	1.4	1.6	18.5	21.5	86	630	4500	0.206	0.263	0.082	343	14.1
1x185	20090635	16	1.6	1.7	21	24	96	780	5550	0.164	0.209	0.081	395	17.4
1x240	20090636	18.1	1.7	1.8	24	27	108	980	7200	0.125	0.159	0.08	471	22.7
1x300	20074233	21	1.8	1.8	27.5	30.5	122	1220	9000	0.1	0.128	0.078	547	28.3
1x400		23.8	2	2	30	33	132	1591	12000	0.0778	0.099	0.078	663	37.6
1x500	20132469	26.5	2.2	2.1	33	37	148	1930	15000	0.0605	0.077	0.077	770	47

## TOWERFLEX-A GLOBAL EMC A3GDGHOEU-R 0,6/1 kV

**Application**

These cables are intended for use in wind turbines, suitable for fixed installation at medium mechanical stress. For system design planning, dimensioning of conductor cross-section, current-carrying capacities and reference methods of installation, as well as applicable correction factors, the specific data of IEC 60364-5-52 have to be considered.

**Global data**

Brand	TOWERFLEX-A GLOBAL EMC
Type designation	A3GDGHOEU-R
Standard	AS/NZS 1125:2001 Based on IEC 60502-1

**Design features**

Conductor	Aluminium, stranded wire class 2, soft annealed, acc. to IEC 60228 / DIN EN 60228
Insulation	Rubber, compound type EPR acc. to IEC 60502-1
Screen over inner sheath	Laying up of tinned copper wires Covering > 90 %
Outer sheath	Rubber, compound type 5GM3 acc. to DIN VDE 0207 Part 21
Outer sheath colour	Black

**Electrical parameters**

Rated voltage	0.6/1 kV (600/1000V)
Max. permissible operating voltage AC	0.7/1.2 kV

**Chemical parameters**

Flame propagation	DIN EN 60332-1-2
Resistance to oil	DIN EN 60811-404
UV-resistance	Cable is UV-resistant
Ozone resistance	DIN EN 60811-403 IEC 60811-403

**Thermal parameters**

Max. permissible temperature at conductor	90 °C
Max. short circuit temperature of the conductor	250 °C
Ambient temperature for fix installation min.	-40 °C

**Mechanical parameters**

Max. tensile load on the conductor	30 N/mm <sup>2</sup>
Min. bending radius	Acc. to DIN VDE 0298 part 3

TOWERFLEX-A GLOBAL EMC A3GDGH0EU-R 0,6/1 kV

Number of cores x cross section	Conductor diameter max. mm	Insulation thickness nom. mm	Outer Sheath Thickness nom. mm	Outer diameter min. mm	Outer diameter max. mm	Bending radius fixed min. mm	Weight (approx.) kg/km	Permissible tensile force max. N	Conductor resistance at 20°C max. Ω/km	Nominal operating capacitance μF/km	Current carrying capacity (1) A	Short Circuit Current (conductor) kA
1x70/10	9.9	3	1.8	19.5	22.5	135	630	2100	0.443	0.885	206	6.6
1x240 /10	18.1	2.2	1.8	26.5	28.5	110	1150	7200	0.125	0.939	471	22.7
1x300 /16	21	2.4	1.8	29.5	31.5	122	1360	9000	0.1	1.019	547	28.3
1x400 /16	23.7	2.6	2	33	35	136	1767	12000	0.078	1.042	663	37.6
1x500 /16	26.5	2.8	2.1	36.5	38.5	150	2162	15000	0.061	1.064	770	47

Oil resistance acc. to DIN EN 60811-2-1: 24h at 100°C

Cognis Breox SL 320

Shell Tivela SC 320

IRM 902

Texaco Meropa 320

Texaco Pinnacle WM 320

Tribol 1710/320

Mobil SHC 524

Texaco Rando HDZ LT 32

Texaco Rando WM 32

Resistance to cooling fluids acc. to .IEC 60811-2-1: 24h at 60°C

Dowcal 10 (50% Ethylen glycol)

Havoline XLC +B -40 (50% Ethylen glycol)

## WINDFLEX GLOBAL EMC S-3GDSHÖU 0,6/1 kV



## Application

These cables are intended for use in wind turbines. Suitable at medium mechanical strain in flexible applications as well as for fixed installation. For system design planning, dimensioning of conductor cross-section, current-carrying capacities and reference methods of installation as well as applicable correction factors the specific data of IEC 60364-5-52 have to be considered.

## Global data

Brand	WINDFLEX GLOBAL EMC
Type designation	S-3GDSHÖEU
Standard	UL Style 4537, AWM UL 758 based on DIN VDE 0250

## Design features

Conductor	Plain copper, fine wire class 5 acc. IEC 60228 / DIN EN 60228
Insulation	Rubber, compound Class 28 UL Style 3775, type 3GI3 acc. to DIN VDE 0207 part 20
Core identification	acc. to HD 308
Screen	Spinning of tinned copper wires, covering > 90 % (Optional: mixed braid of tinned copper wires and polyester yarn)
Outer sheath	Rubber, compound CPE, class 42 UL Style 4537, type 5GM3 acc. to DIN VDE 0207 part 21
Outer sheath colour	Black

## Electrical parameters

Rated voltage	0.6/1 kV (600/1000V)
Max. permissible operating voltage AC	1.2 kV
AC test voltage	3.5 kV

## Chemical parameters

Flame propagation	DIN EN 60332-1-2
Resistance to oil	acc. to IEC 60811-404 (DIN EN 60811-404)
UV-resistance	Cable is UV-resistant
Ozone resistance	DIN EN 60811-403 IEC 60811-403

## Thermal parameters

Max. permissible temperature at conductor	90 °C
Max. short circuit temperature of the conductor	250 °C
Ambient temperature for fix installation min.	-40 °C
Ambient temp. in fully flex. operation min.	-40 °C

## Mechanical parameters

Max. tensile load on the conductor	15 N/mm <sup>2</sup>
Torsional stress +/-	100 °/m
Min. bending radius	moving: 10 X D; fixed: 6 X D

WINDFLEX GLOBAL EMC S-3GDSH0U 0,6/1 kV

Number of cores x cross section	Part number	Conductor diameter max. mm	Outer diameter min. mm	Outer diameter max. mm	Weight (approx.) kg/km	Permissible tensile force max. N	Conductor resistance at 20°C max. Ω/km	Nominal operating capacitance μF/km	Inductive Reactance (at 50Hz) Ω/km	Current carrying capacity (1) A	Short Circuit Current (conductor) kA
1x95	20088401	12.6	22	24	1280	1425	0.206	0.65	0.098	328	13.59
1x120	20074662	14.8	25	27	1600	1800	0.161	0.75	0.095	383	17.16
1x150	20140745	16	26.5	29	1940	2250	0.129	0.73	0.095	444	21.45
1x185	20074667	17.7	29	32	2350	2775	0.106	0.74	0.094	510	26.46
1x240	20074676	20.2	32	35	2880	3600	0.08	0.77	0.091	607	34.32
1x300	20129352	22.7	35	38	3530	4500	0.064	0.8	0.09	703	42.9



## WINDFLEX GLOBAL LSOH S-3GSHXOEU 0,6/1 kV

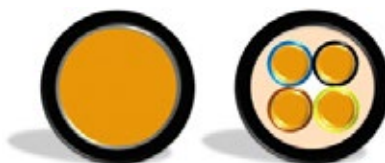

### Application

These cables are intended for use in wind turbines. Suitable at medium mechanical strain in flexible applications as well as for fixed installation. For system design planning, dimensioning of conductor cross-section, current-carrying capacities and reference methods of installation as well as applicable correction factors the specific data of IEC 60364-5-52 have to be considered.

### Global data

Brand	WINDFLEX GLOBAL LSOH
Type designation	S-3GSHXOEU
Standard	based on DIN VDE 0250 UL Style 21465, AWM UL 758, File no. E250813 Based on DIN EN 50525-3-21

### Design features

Conductor	Plain copper, fine wire class 5 acc. IEC 60228 / DIN EN 60228
Insulation	Rubber, compound type 3GI3 acc. to DIN VDE 0207 Teil 20
Core identification	acc. to HD 308
Inner sheath	Rubber, compound type GM1b acc. to DIN VDE 0207 part 21
Outer sheath	Rubber, compound type HXM1, UL Style 21465
Outer sheath colour	Black

### Electrical parameters

Rated voltage	0.6/1 kV (600/1000V)
Max. permissible operating voltage AC	0.7/1.2 kV
Max. permissible operating voltage DC	0.9/1.8 kV
AC test voltage	3.5 kV

### Chemical parameters

Smoke emission	DIN EN 61034-2
Flame propagation	DIN EN 60332-3-24 DIN EN 60332-1-2
Resistance to oil	acc. to IEC 60811-404 (DIN EN 60811-404)
UV-resistance	Cable is UV-resistant
Ozone resistance	DIN EN 60811-403 IEC 60811-403

### Thermal parameters

Max. permissible temperature at conductor	90 °C
Max. short circuit temperature of the conductor	250 °C
Ambient temperature for fix installation min.	-40 °C
Ambient temp. in fully flex. operation min.	-40 °C

### Mechanical parameters

Max. tensile load on the conductor	15 N/mm <sup>2</sup>
Torsional stress +/-	150 °/m
Min. bending radius	Acc. to DIN VDE 0298 part 3

WINDFLEX GLOBAL L50H 5-3GSHX0EU 0.6/1kV

Number of cores x cross section	Part number	Conductor diameter max. mm	Inner Sheath Thickness nom. mm	Outer Sheath Thickness nom. mm	Outer diameter min. mm	Outer diameter max. mm	Bending radius free moving min. mm	Weight (approx.) kg/km	Permissible tensile force max. N	Conductor resistance at 20°C max. Ω/km	AC resistance at max. conductor temp. Ω/km	Inductive Reactance (at 50Hz) Ω/km	Current carrying capacity (1) A	Short Circuit Current (conductor) kA
2x1,5		1.5		1.5	8.5	11	44	98	45	13.3	16.958	0.21	23	0.21
3G1,5		1.5		1.6	9	11.5	46	142	68	13.3	16.958	0.106	23	0.21
4G1,5	20124964	1.5		1.7	10	12.5	63	182	90	13.3	16.958	0.113	23	0.21
5x1,5		1.5		1.8	11	14	70	224	113	13.3	16.958	0.117	23	0.21
4G2,5	20110023	2		1.9	11.5	14.5	73	270	150	7.98	10.175	0.108	32	0.36
5G2,5	20110143	2		2	13	16	80	330	188	7.98	10.175	0.113	32	0.36
3x4		2.5		1.9	13	16	80	313	180	4.95	6.311	0.1	42	0.57
2x4	20267600	2.5		1.9	11.5	14	70	265	120	4.95	6.311	0.98	42	0.57
4x4		2.5		2	14	17	85	383	240	4.95	6.311	0.107	42	0.57
3G6	20097052	3.1		2.1	14	17	85	420	270	3.3	4.208	0.094	54	0.86
4x6		3.1		2.3	16	19	95	514	360	3.3	4.208	0.102	54	0.86
5G6	20101010	3.1		2.3	16.2	21.5	108	640	450	3.3	4.208	0.102	54	0.86
1x10	20158101	4	1.2	1.9	9.5	11	55	200	150	1.91	2.435		86	1.43
2x10		4	1.2	1.9	17	20	100	560	300	1.91	2.435	0.09	86	1.43
3x10		4	1.3	2	18.5	21.5	108	688	450	1.91	2.435	0.09	75	1.43
4x10		4	1.4	2	20.5	23.5	118	642	600	1.91	2.435	0.097	75	1.43
5G10	20092061	4	1.4	2.79	24	27	135	1060	750	1.91	2.435	0.098	75	1.43
1x16	20158098	5.1	1.4	2.1	10.8	13.4	67	260	240	1.21	1.543		100	2.29
3x16		5.1	1.4	2.1	21.5	24.5	123	946	720	1.21	1.543	0.084	100	2.29
5G16	20181802	5.1	1.5	2.79	27	30	150	1650	1200	1.21	1.543	0.096	100	2.29
4x16		5.1	1.4	2.79	24.5	27.5	138	1242	960	1.21	1.543	0.092	100	2.29
5x16		5.1	1.5	2.79	27	30	150	1501	1200	1.21	1.543	0.096	100	2.29
1x25	20158096	6.2		2	11.5	14.5	73	370	375	0.784	1	0.106	135	3.58
3x25		6.2	1.5	2.79	26.5	29.5	148	1270	1125	0.784	1	0.083	127	3.58
3G25	20074664	6.2	1.5	2.79	26.5	29.5	148	1280	1125	0.784	1	0.083	127	3.58
4G25	20074683	6.2	1.6	3.18	29	32	160	1690	1500	0.784	1	0.09	127	3.58
5G25	20088355	6.2	1.7	3.18	32	36	180	2400	1875	0.784	1	0.095	127	3.58
1x35	20158099	7.8		2.2	13	17	85	510	525	0.554	0.706	0.102	169	5.01
3x35	20077895	7.8	1.6	2.79	30	33	165	1680	1575	0.554	0.706	0.08	158	5.01
3G35	20100280	7.8	1.6	2.79	30	33	165	1680	1575	0.554	0.706	0.08	158	5.01
4G35		7.6	1.7	3.18	32.5	36.5	183	2338	2100	0.554	0.706	0.087	158	5.01
5x35	20223861	7.6	1.8	3.18	36	40	200	3230	2625	0.554	0.706	0.091	158	5.01
5G35		7.6	1.8	3.18	36	40	200	2849	2625	0.554	0.706	0.091	158	5.01
1x50	20158097	9.6		2.4	15.5	18.5	93	700	750	0.386	0.492	0.1	207	7.15
3G50	20088767	9.6	1.5	2.79	34	38	190	2240	2250	0.386	0.492	0.079	192	7.15
4G50	20074673	9.6	1.9	3.36	38	42	210	3010	3000	0.386	0.492	0.086	192	7.15
5G50		9.6	2.1	3.36	42	46	230	3941	3750	0.386	0.492	0.09	192	7.15
1x70	20080406	11.1		2.6	18	21	105	930	1050	0.272	0.347	0.095	268	10.01
3x70	20077868	11.1	1.9	3.36	39.5	43.5	218	3370	3150	0.272	0.347	0.076	246	10.01
4G70	20116041	11.1	2	4.06	44.5	48.5	243	4310	4200	0.272	0.347	0.083	246	10.01
5G70		11.1	2.3	4.06	49	53	265	5515	5250	0.272	0.347	0.087	246	10.01
1x95	20098693	12.6		2.8	20	23	115	1170	1425	0.206	0.263	0.094	328	13.59
3x95	20098205	12.6	2.1	4.06	45.5	49.5	248	4450	4275	0.206	0.263	0.075	298	13.59
4x95	20088769	12.6	2.3	4.07	50	55	275	5570	5700	0.206	0.263	0.081	298	13.59
4G95	20113299	12.6	2.3	4.07	50	55	275	5570	5700	0.206	0.263	0.085	298	13.59
1x120	20158094	14.6		3	22.5	25.5	128	1480	1800	0.161	0.205	0.092	383	17.16
3x120		14.6	2.2	4.06	49	53	265	5517	5400	0.161	0.205	0.074	346	17.16
1x150	20158095	16		3.2	25	28	140	1800	2250	0.129	0.164	0.091	444	21.45
3x150	20087235	16	2.4	4.07	55	60	300	6630	6750	0.129	0.164	0.074	399	21.45
1x185	20077913	17.7		3.4	27	30	150	2200	2775	0.106	0.135	0.09	510	26.46
3x185		17.7	2.8	5.08	60	65	325	8290	8325	0.106	0.135	0.073	456	26.46
1x240	20074306	20.2		3.5	30	33	165	2710	3600	0.08	0.102	0.088	607	34.32
3x240	20076102	20.2	2.8	5.59	68	74	370	10360	10800	0.08	0.102	0.073	538	34.32
1x300	20074681	22.7		3.6	33	37	185	3360	4500	0.064	0.082	0.087	703	42.9
1x400	20158100	26.2		3.8	37	41	205	4850	6000	0.049	0.062	0.085	823	57.2
24G1	20074686	1.25	1.4	2.8	25	26.4	132	840	360	19.5	24.863	0.111	6	0.14
12G1,5	20181801	1.5		2.9	17.5	20.5	103	490	270	13.3	16.958	0.12	10	0.21
7G1,5		1.5		2.6	14.5	17	85	385	158	13.3	16.958	0.12	11	0.21
12G2,5	20090101	2		3.1	20.5	23.5	118	710	450	7.98	10.175	0.117	13	0.36
16G2,5	20074688	2	1.5	2.79	25	27	135	1010	600	7.98	10.175	0.12	11	0.36

flame propagation: single core design: Square diameter up to 25mm<sup>2</sup> = DIN EN 60332-1-2, square diameter 35mm<sup>2</sup> and larger DIN EN 60332-3-24 "C", multi core design = DIN EN 60332-1-2

(1) Recommended current carrying capacities: Single core cables: acc. to IEC 60364-5-52 table B 52.12 resp. DIN VDE 0298 part 4, table 6, Method F resp. G Multi core cables: acc. to IEC 60364-5-52 table B 52.12 resp. DIN VDE 0298 part 4, table 6 Method E

## WINDFLEX GLOBAL EMC LSOH S-3GC SHXOEU 0,6/1 kV



### Application

These cables are intended for use in wind turbines. Suitable at medium mechanical strain in flexible applications as well as for fixed installation.

### Global data

Brand	WINDFLEX GLOBAL EMC LSOH
Type designation	S-3GC SHXOEU
Standard	based on DIN VDE 0250 UL Style 21465, AWM UL 758, File no. E250813

### Design features

Conductor	Copper tinned (plain optional), fine wire class 5 according to DIN EN 60228
Insulation	Rubber, compound type 3GI3 acc. to DIN VDE 0207 Teil 20
Core identification	acc. to HD 308
Inner sheath	Rubber, compound type GM1b acc. to DIN VDE 0207 part 21
Screen over inner sheath	Braid of tinned copper wires, Covering > 90 % Max. Transfer impedance 10mΩm (up to 10MHz)
Outer sheath	Rubber, compound type HXM1, UL Style 21465
Outer sheath colour	Black

### Electrical parameters

Rated voltage	0.6/1 kV (600/1000V)
Max. permissible operating voltage AC	1.2 kV
AC test voltage	3.5 kV

### Chemical parameters

Smoke emission	DIN EN 61034-2
Flame propagation	DIN EN 60332-1-2
Resistance to oil	acc. to IEC 60811-404 (DIN EN 60811-404)
UV-resistance	Cable is UV-resistant
Ozone resistance	DIN EN 60811-403 IEC 60811-403

### Thermal parameters

Max. permissible temperature at conductor	90 °C
Max. short circuit temperature of the conductor	250 °C
Ambient temperature for fix installation min.	-40 °C
Ambient temp. in fully flex. operation min.	-40 °C

### Mechanical parameters

Max. tensile load on the conductor	15 N/mm <sup>2</sup>
Torsional stress +/-	100 °/m
Min. bending radius	moving: 10 X D; fixed: 6 X D

WINDFLEX GLOBAL EMC LSOH 5-3GCSHXOEU 0,6/1 kV

Number of cores x cross section	Part number	Conductor diameter max. mm	Insulation thickness nom. mm	Inner Sheath Thickness nom. mm	Outer Sheath Thickness nom. mm	Outer diameter min. mm	Outer diameter max. mm	Bending radius free moving min. mm	Weight (approx.) kg/km	Conductor resistance at 20°C max. Ω/km	AC resistance at max. conductor temp. Ω/km	Inductive Reactance (at 50Hz) Ω/km	Current carrying capacity (1) A	Short Circuit Current (conductor) max. (1s) kA
3G1,5		3.1	1.1		2.3	16	19	95	514	3.3	4.208	0.102	54	0.86
4G1,5		7.6	1.4	1.8	3.18	36	40	200	2849	0.554	0.706	0.091	158	5.01
7G1,5		1.5	0.8			16.5	17.9	179	431	13.7	17.468		11	0.18
4G2,5		2	0.9			13.8	15	150	326	8.21	10.468		32	0.31
5G2,5		2	0.9			15.1	16.3	163	386	8.21	10.468		32	0.31
4G4		2.5	1.1			16.5	17.9	179	493	5.09	6.49		42	0.49
2x6		3.1	1.1			15.3	16.5	165	365	3.39	4.322		63	0.73
4G6		3.1	1.1			18.4	20	200	632	3.39	4.322		54	0.73
3G10		4	1.2	1.3		20.5	24.5	245	1121	1.95	2.486		75	1.22
4G10		4	1.2	1.4		24	28	280	1462	1.95	2.486		75	1.22
3x95		13	1.8	2.1		48	52	520	4955	0.21	0.268		298	11.59
4x95		13	1.8	2.3		53	57	570	6033	0.21	0.268		298	11.59
25G1	20077825	1.3	0.8	1		26.5	27.9	279	1080	20	25.501		6	0.12
37G1	20074671	1.3	0.8	1.2		28.6	30	300	1290	20	25.501		5	0.14
12G1,5	20077824	1.5	0.8	1.2		18	22	220	700	13.7	17.468		9	0.18
32G1,5	20076199	1.5	0.8	1.6		32	33.5	335	1660	13.7	17.468		6	0.18

## WINDFLEX GLOBAL EMC S-3GCSHOEU 0,6/1 kV



### Application

These cables are intended for use in wind turbines. Suitable at medium mechanical strain in flexible applications as well as for fixed installation. For system design planning, dimensioning of conductor cross-section, current-carrying capacities and reference methods of installation as well as applicable correction factors the specific data of IEC 60364-5-52 have to be considered.

### Global data

Brand	WINDFLEX GLOBAL EMC
Type designation	S-3GCSHOEU
Standard	based on DIN VDE 0250 UL Style 4537, AWM UL 758

### Design features

Conductor	Tinned copper (bare optional), fine wire class 5 acc. IEC 60228 / DIN EN 60228
Insulation	Rubber, compound Class 28 UL Style 3775, type 3G13 acc. to DIN VDE 0207 part 20
Core identification	acc. to HD 308
Screen	Braid of tinned copper wires, covering > 90 %. Max. transfer impedance 10mΩm (up to 10MHz).
Outer sheath	Rubber, compound CPE, class 42 UL Style 4537, type 5GM3 acc. to DIN VDE 0207 part 21
Outer sheath colour	Black

### Electrical parameters

Rated voltage	0.6/1 kV (600/1000V)
Max. permissible operating voltage AC	1.2 kV
AC test voltage	3.5 kV

### Chemical parameters

Flame propagation	DIN EN 60332-1-2
Resistance to oil	acc. to IEC 60811-404 (DIN EN 60811-404)
UV-resistance	Cable is UV-resistant
Ozone resistance	DIN EN 60811-403 IEC 60811-403

### Thermal parameters

Max. permissible temperature at conductor	90 °C
Max. short circuit temperature of the conductor	250 °C
Ambient temperature for fix installation min.	-40 °C
Ambient temp. in fully flex. operation min.	-40 °C

### Mechanical parameters

Max. tensile load on the conductor	15 N/mm <sup>2</sup>
Torsional stress +/-	100 °/m
Min. bending radius	moving: 10 X D; fixed: 6 X D



WINDFLEX GLOBAL EMC S-3GCSHOEU 0,6/1 kV

Number of cores x cross section	Conductor diameter max. mm	Outer diameter min. mm	Outer diameter max. mm	Weight (approx.) kg/km	Permissible tensile force max. N	Conductor resistance at 20°C max. Ω/km	Current carrying capacity (1) A	Short Circuit Current (conductor) kA
25G1	1.3	26	30	826	375	20	6	0.14
3G1,5	1.5	10.9	11.8	191	68	13.7	23	0.21
4G1,5	1.5	11.9	12.9	233	90	13.7	23	0.21
7G1,5	1.5	16.5	17.9	423	158	13.7	11	0.21
12G1,5	1.5	18	22	674	270	13.7	9	0.21
32G1,5	1.5	30.5	34.5	1545	720	13.7	6	0.21
4G2,5	2	13.8	15	319	150	8.21	32	0.36
5G2,5	2	15.1	16.3	378	188	8.21	32	0.36
4G4	2.5	16.5	17.9	486	240	5.09	42	0.57
2x6	3.1	15.3	16.5	358	180	3.39	63	0.86
4G6	3.1	18.4	20	620	360	3.39	54	0.86
3G10	4	20.5	24.5	1105	450	1.95	75	1.43
4G10	4	24	28	1440	600	1.95	75	1.43
3x95	12.6	48	52	4935	4275	0.21	298	13.59
4x95	12.6	53	57	6008	5700	0.21	298	13.59

## WINDFLEX (GLOBAL) LSOH S-3GSHXOEU 0,6/1 kV



### Application

These cables are intended for use in wind turbines. Suitable at medium mechanical strain in flexible applications as well as for fixed installation. For system design planning, dimensioning of conductor cross-section, current-carrying capacities and reference methods of installation as well as applicable correction factors the specific data of IEC 60364-5-52 have to be considered.

### Global data

Brand	WINDFLEX (GLOBAL) LSOH
Type designation	S-3GSHXOEU
Standard	Based on DIN EN 50525-3-21 based on DIN VDE 0250

### Design features

Conductor	Plain copper, fine wire class 5 acc. IEC 60228 / DIN EN 60228
Insulation	Rubber, compound type 3GI3 acc. to DIN VDE 0207 Teil 20
Core identification	acc. to HD 308
Inner sheath	Rubber, compound type GM1b acc. to DIN VDE 0207 part 21
Outer sheath	Rubber, compound type HXM1
Outer sheath colour	Black

### Electrical parameters

Rated voltage	0.6/1 kV (600/1000V)
Max. permissible operating voltage AC	1.2 kV
AC test voltage	3.5 kV

### Chemical parameters

Smoke emission	DIN EN 61034-2
Flame propagation	DIN EN 60332-1-1 DIN EN 60332-1-2
Resistance to oil	acc. to IEC 60811-404 (DIN EN 60811-404)
UV-resistance	Cable is UV-resistant
Ozone resistance	DIN EN 60811-403 IEC 60811-403

### Thermal parameters

Max. permissible temperature at conductor	90 °C
Max. short circuit temperature of the conductor	250 °C
Ambient temperature for fix installation min.	-40 °C
Ambient temp. in fully flex. operation min.	-40 °C

### Mechanical parameters

Max. tensile load on the conductor	15 N/mm <sup>2</sup>
Torsional stress +/-	150 °/m
Min. bending radius	Acc. to DIN VDE 0298 part 3

WINDFLEX (GLOBAL) LSOH S-3GSHXOEU 0,6/1 kV

Number of cores x cross section	Part number	Conductor diameter max. mm	Insulation thickness nom. mm	Inner Sheath Thickness nom. mm	Outer Sheath Thickness nom. mm	Outer diameter min. mm	Outer diameter max. mm	Bending radius free moving min. mm	Weight (approx.) kg/km	Conductor resistance at 20°C max. Ω/km	AC resistance at max. conductor temp. Ω/km	Inductive Reactance (at 50Hz) Ω/km	Current carrying capacity (1) A	Short Circuit Current (conductor) max. (1s) kA
2x1,5		1.5	0.8		1.5	8.5	11	44	98	13.3	16.958	0.21	23	0.21
3x1,5		1.5	0.8		1.6	9	11.5	46	142	13.3	16.958	0.106	23	0.21
4x1,5		1.5	0.8		1.7	10	12.5	63	182	13.3	16.958	0.113	23	0.21
5x1,5		1.5	0.8		1.8	11	14	70	224	13.3	16.958	0.117	23	0.21
3x2,5		2	0.9		1.8	11	14	70	217	7.98	10.175	0.101	32	0.36
4x2,5		2	0.9		1.9	11.5	14.5	73	265	7.98	10.175	0.108	32	0.36
5G2,5		2	0.9		2	13	16	80	326	7.98	10.175	0.113	32	0.36
3x4		2.5	1.1		1.9	13	16	80	313	4.95	6.311	0.1	42	0.57
4x4		2.5	1.1		2	14	17	85	383	4.95	6.311	0.107	42	0.57
3G6		3.1	1.1		2.1	14	17	85	407	3.3	4.208	0.094	54	0.86
4x6		3.1	1.1		2.3	16	19	95	514	3.3	4.208	0.102	54	0.86
2x10		4	1.2	1.2	1.9	17	20	100	560	1.91	2.435	0.09	86	1.43
3x10		4	1.2	1.3	2	18.5	21.5	108	688	1.91	2.435	0.09	75	1.43
4x10		4	1.2	1.4	2	20.5	23.5	118	642	1.91	2.435	0.097	75	1.43
5G10		4	1.2	1.4	2.79	24	27	135	1095	1.91	2.435	0.101	75	1.43
3x16		5.1	1.2	1.4	2.1	21.5	24.5	123	946	1.21	1.543	0.084	100	2.29
4x16		5.1	1.2	1.4	2.79	24.5	27.5	138	1242	1.21	1.543	0.092	100	2.29
5x16		5.1	1.2	1.5	2.79	27	30	150	1501	1.21	1.543	0.096	100	2.29
1x25		6.2	1.4		2	11.5	14.5	73	364	0.784	1	0.106	135	3.58
3x25		6.2	1.4	1.5	2.79	26.5	29.5	148	1270	0.784	1	0.083	127	3.58
3G25	20119152	6.2	1.4	1.5	2.79	26.5	29.5	148	1280	0.784	1	0.083	127	3.58
4G25	20117904	6.2	1.4	1.6	3.18	29	32	160	1590	0.784	1	0.09	127	3.58
5G25		6.2	1.4	1.7	3.18	32	36	180	2380	0.784	1	0.095	127	3.58
1x35		7.8	1.4		2.2	13	17	85	491	0.554	0.706	0.102	169	5.01
3x35	20077895	7.8		1.6	2.79	30	33	165	1680	0.554	0.706	0.08	158	5.01
3G35	20100280	7.8		1.6	2.79	30	33	165	1680	0.554	0.706	0.08	158	5.01
4G35	20195252	7.6	1.4	1.7	3.18	34.5	36.5	183	2360	0.554	0.706	0.087	158	5.01
5G35	20195254	7.6	1.4	1.8	3.18	38	40	200	3190	0.554	0.706	0.091	158	5.01
1x50		9.6	1.6		2.4	15.5	18.5	93	682	0.386	0.492	0.1	207	7.15
3G50		9.6	1.6	1.5	2.79	34	38	190	2200	0.386	0.492	0.079	192	7.15
4G50	20132219	9.6	1.6	1.9	3.36	38	42	210	3020	0.386	0.492	0.086	192	7.15
5x50		9.6	1.6	2.1	3.36	42	46	230	3941	0.386	0.492	0.09	192	7.15
1x70	20121203	11.1	1.6		2.6	18	21	105	930	0.272	0.347	0.095	268	10.01
3x70		11.1	1.6	1.9	3.36	39.5	43.5	218	3440	0.272	0.347	0.076	246	10.01
4G70		11.1	1.6	2	4.06	44.5	48.5	243	4470	0.272	0.347	0.083	246	10.01
5G70	20195222	11.1	1.6	2.3	4.06	50	53	265	5860	0.272	0.347	0.087	246	10.01
1x95		12.6	1.8		2.8	20	23	115	1160	0.206	0.263	0.094	328	13.59
3x95		12.6	1.8	2.1	4.06	45.5	49.5	248	4410	0.206	0.263	0.075	298	13.59
4x95		12.6	1.8	2.3	4.07	50	55	275	5530	0.206	0.263	0.081	298	13.59
4G95	20119153	12.6	1.8	2.3	4.07	50	55	275	5560	0.206	0.263	0.085	298	13.59
1x120	20129040	14.6	1.8		3	22.5	25.5	128	1480	0.161	0.205	0.092	383	17.16
3x120		14.6	1.8	2.2	4.06	49	53	265	5517	0.161	0.205	0.074	346	17.16
1x150	20119480	16	2		3.2	25	28	140	1800	0.129	0.164	0.091	444	21.45
3x150		16	2	2.4	4.07	55	60	300	6580	0.129	0.164	0.074	399	21.45
1x185	20077913	17.7			3.4	27	30	150	2200	0.106	0.135	0.09	510	26.46
3x185		17.7	2.2	2.8	5.08	60	65	325	8290	0.106	0.135	0.073	456	26.46
1x240	20114169	20.2	2.4		3.5	30	33	165	2710	0.08	0.102	0.088	607	34.32
3x240	20117151	20.2	2.4	2.8	5.59	68	74	370	9920	0.08	0.102	0.073	538	34.32
1x300	20117382	22.7	2.6		3.6	33	37	185	3360	0.064	0.082	0.087	703	42.9
1x400		26.2	2.8		3.8	37	41	205	4421	0.049	0.062	0.085	823	57.2
24G1	20117381	1.25	0.8	1.4	2.8	25	26.4	132	840	19.5	24.863	0.111	6	0.14
7G1,5		1.5	0.8		2.6	14.5	17	85	385	13.3	16.958	0.12	11	0.21
12G2,5	20117341	2	0.9		3.1	20.5	23.5	118	710	7.98	10.175	0.117	13	0.36
16G2,5	20130210	2	0.9	1.5	2.79	25	27	135	1010	7.98	10.175	0.12	11	0.36
7G25	20195562	6.21	1.2		2.1	32.1	34.1	204.6	3050	0.764		0.079	60	3.58

(1) Recommended current carrying capacities: Singel core cables: acc. to IEC 60364-5-52 table B 52.12 resp. DIN VDE 0298 part 4, table 6, Method F resp. G Multi core cables: acc. to IEC 60364-5-52 table B 52.12 resp. DIN VDE 0298 part 4, table 6 Method E

## WINDFLEX GLOBAL EMC LSOH S-3GCSHXOEU 0,6/1 kV



### Application

These cables are intended for use in wind turbines. Suitable at medium mechanical strain in flexible applications as well as for fixed installation.

### Global data

Brand	WINDFLEX GLOBAL EMC LSOH
Type designation	S-3GCSHXOEU
Standard	based on DIN VDE 0250 UL Style 21465, AWM UL 758, File no. E250813

### Design features

Conductor	Copper tinned (plain optional), fine wire class 5 according to DIN EN 60228
Insulation	Rubber, compound type 3GI3 acc. to DIN VDE 0207 Teil 20
Core identification	acc. to HD 308
Inner sheath	Rubber, compound type GM1b acc. to DIN VDE 0207 part 21
Screen over inner sheath	Braid of tinned copper wires, Covering > 90 % Max. Transfer impedance 10mΩm (up to 10MHz)
Outer sheath	Rubber, compound type HXM1, UL Style 21465
Outer sheath colour	Black

### Electrical parameters

Rated voltage	0.6/1 kV (600/1000V)
Max. permissible operating voltage AC	1.2 kV
AC test voltage	3.5 kV

### Chemical parameters

Smoke emission	DIN EN 61034-2
Flame propagation	DIN EN 60332-1-2
Resistance to oil	acc. to IEC 60811-404 (DIN EN 60811-404)
UV-resistance	Cable is UV-resistant
Ozone resistance	DIN EN 60811-403 IEC 60811-403

### Thermal parameters

Max. permissible temperature at conductor	90 °C
Max. short circuit temperature of the conductor	250 °C
Ambient temperature for fix installation min.	-40 °C
Ambient temp. in fully flex. operation min.	-40 °C

### Mechanical parameters

Max. tensile load on the conductor	15 N/mm <sup>2</sup>
Torsional stress +/-	100 °/m
Min. bending radius	moving: 10 X D; fixed: 6 X D

WINDFLEX GLOBAL EMC LSOH 5-3GCSHXOEU 0,6/1 kV

Number of cores x cross section	Part number	Conductor diameter max. mm	Insulation thickness nom. mm	Inner Sheath Thickness nom. mm	Outer Sheath Thickness nom. mm	Outer diameter min. mm	Outer diameter max. mm	Bending radius free moving min. mm	Weight (approx.) kg/km	Conductor resistance at 20°C max. Ω/km	AC resistance at max. conductor temp. Ω/km	Inductive Reactance (at 50Hz) Ω/km	Current carrying capacity (1) A	Short Circuit Current (conductor) max. (1s) kA
3G1,5		3.1	1.1		2.3	16	19	95	514	3.3	4.208	0.102	54	0.86
4G1,5		7.6	1.4	1.8	3.18	36	40	200	2849	0.554	0.706	0.091	158	5.01
7G1,5		1.5	0.8			16.5	17.9	179	431	13.7	17.468		11	0.18
4G2,5		2	0.9			13.8	15	150	326	8.21	10.468		32	0.31
5G2,5		2	0.9			15.1	16.3	163	386	8.21	10.468		32	0.31
4G4		2.5	1.1			16.5	17.9	179	493	5.09	6.49		42	0.49
2x6		3.1	1.1			15.3	16.5	165	365	3.39	4.322		63	0.73
4G6		3.1	1.1			18.4	20	200	632	3.39	4.322		54	0.73
3G10		4	1.2	1.3		20.5	24.5	245	1121	1.95	2.486		75	1.22
4G10		4	1.2	1.4		24	28	280	1462	1.95	2.486		75	1.22
3x95		13	1.8	2.1		48	52	520	4955	0.21	0.268		298	11.59
4x95		13	1.8	2.3		53	57	570	6033	0.21	0.268		298	11.59
25G1	20077825	1.3	0.8	1		26.5	27.9	279	1080	20	25.501		6	0.12
37G1	20074671	1.3	0.8	1.2		28.6	30	300	1290	20	25.501		5	0.14
12G1,5	20077824	1.5	0.8	1.2		18	22	220	700	13.7	17.468		9	0.18
32G1,5	20076199	1.5	0.8	1.6		32	33.5	335	1660	13.7	17.468		6	0.18



## PROTODUR NYY 0,6/1 kV CPR Eca



### Application

Distribution cables, connecting cables and installation cables in power stations, industrial plants and distribution mains.  
Laying: in earth, in tube, free in air, indoors, in concrete and in water  
UV-resistant

### Global data

Brand	PROTODUR
Type designation	NY Y
Standard	DIN VDE 0276-603 Based on IEC 60502-1
Construction product regulation (CPR)	CPR acc. to DIN EN 50575, class and DoP code see data table below, DoP see <a href="http://www.prysmiangroup.com/cpr">www.prysmiangroup.com/cpr</a>

### Design features

Conductor	Bare copper acc. to DIN EN 60228 round, single wire (RE), class 1 or round, multi wire, compacted (RM), class 2 or sector shaped, multi wire (SM), class 2
Insulation	Polyvinylchloride (PVC)
Core identification	Colours of cores acc. to DIN VDE 0293-308 1 core: NYY-O black; NYY-J green/yellow 2 cores: NYY-O blue, brown 3 cores: NYY-O brown, black, grey; NYY-J green/yellow, blue, brown 4 cores: NYY-O blue, brown, black, grey; NYY-J green/yellow, brown, black, grey 4 cores with reduced conductor: NYY-O blue, brown, black, grey; NYY-J green/yellow, brown, black, grey 5 cores: NYY-J green/yellow, blue, brown, black, grey
Separator	flame retardant fleece
Inner covering	Extruded or lapped (except for single core cables)
Outer sheath	Polyvinylchloride (PVC)
Outer sheath colour	Black

### Electrical parameters

Rated voltage	0.6/1 kV (600/1000V)
Max. permissible operating voltage AC	1.2 kV
Max. permissible operating voltage DC	1.8 kV

### Chemical parameters

Reaction to fire	Flame resistant according to DIN EN 60332-1-1 and DIN EN 60332-1-2
------------------	--

### Thermal parameters

Max. permissible temperature at conductor	70 °C
Max. short circuit temperature of the conductor	160 °C ≤ 300mm <sup>2</sup> 140 °C >= 300mm <sup>2</sup>
Laying temperature min.	-5 °C

PROTODUR NYY 0,6/1 kV CPR Eca

Number of cores x cross section	Art. Des. O/J	Part number	Insulation thickness nom. mm	Outer diameter nom. mm	Bending radius fixed min. mm	Weight (approx.) kg/km	Conductor resistance at 20°C max. Ω/km	AC resistance at max. conductor temp. Ω/km	Current-carrying capacity during normal operation, laid in the ground (1) A	Current carrying capacity free in air (2) A	Short Circuit Current (conductor) kA	Fire load value kWh/m	CPR fire class	CPR DoP-Code
2x1,5 RE	-O	20195909	0.8	12	144	210	12.1	14.5			0.173	0.67	Eca	1001203
2x2,5 RE	-O	20195910	0.8	12	144	250	7.41	8.87			0.287	0.75	Eca	1001203
2x4 RE	-O	20195911	1	14	168	360	4.61	5.52			0.46	0.96	Eca	1001203
2x6 RE	-O	20195912	1	15	180	400	3.08	3.69			0.69	1.08	Eca	1001203
2x10 RE	-O	20195913	1	17	204	500	1.83	2.19			1.15	1.28	Eca	1001203
2x16 RE	-O	20195901	1	19	228	700	1.15	1.38			1.84	1.53	Eca	1001203
2x25 RM	-O	20195967	1.2	23	276	1000	0.727	0.87			2.87	2.1	Eca	1001203
3x1,5 RE	-J	20195865	0.8	12	144	230	12.1	14.5	27	19.5	0.173	0.73	Eca	1001203
3x2,5 RE	-J	20195869	0.8	13	156	280	7.41	8.87	36	25	0.287	0.82	Eca	1001203
3x4 RE	-J	20195873	1	15	180	400	4.61	5.52	47	34	0.46	1.06	Eca	1001203
3x6 RE	-J	20195874	1	16	192	460	3.08	3.69	59	43	0.69	1.19	Eca	1001203
3x10 RE	-J	20195875	1	18	216	660	1.83	2.19	79	59	1.15	1.41	Eca	1001203
3x16 RE	-J	20195902	1	20	240	900	1.15	1.38	102	79	1.84	1.67	Eca	1001203
3x25 RM/16RE	-J	20195846	1.2	26	312	1500	0.727	0.87	133	106	2.87	2.5	Eca	1001203
3x35 SM/16RE	-J	20195935	1.2	26	312	1700	0.524	0.627	159	129	4.02	3.28	Eca	1001204
3x50 SM/25RM	-J	20195936	1.4	30	360	2300	0.387	0.463	188	157	5.75	4.06	Eca	1001204
3x70 SM/35SM	-J	20195937	1.4	33	396	2800	0.268	0.321	232	199	8.05	5.06	Eca	1001205
3x95 SM/50SM	-J	20195938	1.6	38	456	4100	0.193	0.232	280	246	10.9	6.49	Eca	1001205
3x95 SM	-J	20195926	1.6	34	408	3350	0.193	0.232	280	246	10.9	4.18	Eca	1001205
3x120 SM/70SM	-J	20195939	1.6	40	480	4700	0.153	0.184	318	285	13.8	7.55	Eca	1001205
3x150 SM/70SM	-J	20195940	1.8	44	528	5600	0.124	0.15	359	326	17.2	9.03	Eca	1001205
3x185 SM/95SM	-J	20195941	2	49	588	7100	0.0991	0.121	406	374	21.3	10.77	Eca	1001205
3x240 SM/120SM	-J	20195942	2.2	55	660	9100	0.0754	0.0926	473	445	27.6	13.45	Eca	1001205
3x6 RE	-O	20195914	1	16	192	460	3.08	3.69	59	43	0.69	1.19	Eca	1001203
3x10 RE	-O	20195915	1	18	216	660	1.83	2.19	79	59	1.15	1.41	Eca	1001203
3x35 SM	-O	20195971	1.2	24	288	1400	0.524	0.627	159	129	4.03	2.18	Eca	1001205
3x50 SM	-O	20195972	1.4	26	312	1850	0.387	0.463	188	157	5.75	2.71	Eca	1001205
4x1,5 RE	-J	20195876	0.8	13	156	260	12.1	14.5	27	19.5	0.173	0.83	Eca	1001203
4x2,5 RE	-J	20195879	0.8	14	168	320	7.41	8.87	36	25	0.287	0.93	Eca	1001203
4x4 RE	-J	20195881	1	16	192	450	4.61	5.52	47	34	0.46	1.22	Eca	1001203
4x6 RE	-J	20195884	1	17	204	550	3.08	3.69	59	43	0.69	1.38	Eca	1001203
4x10 RE	-J	20195886	1	19	228	750	1.83	2.19	79	59	1.15	1.64	Eca	1001203
4x16 RM	-J	20195920	1	21	252	1100	1.15	1.38	102	79	1.84	1.95	Eca	1001203
4x16 RE	-J	20195905	1	21	252	1100	1.15	1.38	102	79	1.84	1.95	Eca	1001203
4x25 RM	-J	20195921	1.2	26	312	1600	0.727	0.87	133	106	2.87	2.71	Eca	1001203
4x35 SM	-J	20195927	1.2	26	312	1750	0.524	0.627	159	129	4.03	3.18	Eca	1001205
4x50 SM	-J	20195928	1.4	30	360	2300	0.387	0.463	188	157	5.75	4.03	Eca	1001205
4x70 SM	-J	20195929	1.4	34	408	3150	0.268	0.321	232	199	8.05	5.02	Eca	1001205
4x95 SM	-J	20195930	1.6	38	456	4250	0.193	0.232	280	246	10.9	6.38	Eca	1001205
4x120 SM	-J	20195931	1.6	42	504	5250	0.153	0.184	318	285	13.8	7.41	Eca	1001205
4x150 SM	-J	20195932	1.8	46	552	6400	0.124	0.15	359	326	17.2	8.77	Eca	1001205
4x185 SM	-J	20195933	2	51	612	7900	0.0991	0.121	406	374	21.3	10.61	Eca	1001205
4x240 SM	-J	20195934	2.2	57	684	10300	0.0754	0.0928	473	445	27.6	12.99	Eca	1001205
4x4 RE	-O	20195916	1	16	192	450	4.61	5.52	47	34	0.46	1.22	Eca	1001203
4x6 RE	-O	20195917	1	17	204	550	3.08	3.69	59	43	0.69	1.38	Eca	1001203

Continues on next page.

Continued from previous page

PROTODUR NYY 0,6/1 kV CPR Eca

Number of cores x cross section	Art. Des. O/J	Part number	Insulation thickness nom. mm	Outer diameter nom. mm	Bending radius fixed min. mm	Weight (approx.) kg/km	Conductor resistance at 20°C max. Ω/km	AC resistance at max. conductor temp. Ω/km	Current-carrying capacity during normal operation, laid in the ground (1) A	Current carrying capacity free in air (2) A	Short Circuit Current (conductor) kA	Fire load value kWh/m	CPR fire class	CPR DoP-Code
4x10 RE	-O	20195919	1	19	228	750	1.83	2.19	79	59	1.15	1.64	Eca	1001203
4x16 RE	-O	20195906	1	21	252	1100	1.15	1.38	102	79	1.84	1.95	Eca	1001203
4x25 RM	-O	20195968	1.2	26	312	1600	0.727	0.87	133	106	2.87	2.71	Eca	1001203
4x35 SM	-O	20195973	1.2	26	312	1750	0.524	0.627	159	129	4.03	3.18	Eca	1001205
4x50 SM	-O	20195974	1.4	30	360	2300	0.387	0.463	188	157	5.75	4.03	Eca	1001205
4x70 SM	-O	20195975	1.4	34	408	3150	0.268	0.321	232	199	8.05	5.02	Eca	1001205
4x95 SM	-O	20195976	1.6	38	456	4250	0.193	0.232	280	246	10.9	6.38	Eca	1001205
4x120 SM	-O	20195977	1.6	42	504	5250	0.153	0.184	318	285	13.8	7.41	Eca	1001205
4x150 SM	-O	20195978	1.8	46	552	6400	0.124	0.15	359	326	17.2	8.77	Eca	1001205
4x185 SM	-O	20195979	2	51	612	7900	0.0991	0.121	406	374	21.3	10.61	Eca	1001205
5x1,5 RE	-J	20195887	0.8	14	168	300	12.1	14.5	27	19.5	0.173	0.93	Eca	1001203
5x2,5 RE	-J	20196070	0.8	15	180	365	7.41	8.87	36	25	0.287	1.06	Eca	1001203
5x4 RE	-J	20195896	1	17	204	500	4.61	5.52	47	34	0.46	1.41	Eca	1001203
5x6 RE	-J	20195898	1	19	228	680	3.08	3.69	59	43	0.69	1.59	Eca	1001203
5x10 RE	-J	20195900	1	21	252	930	1.83	2.19	79	59	1.15	1.9	Eca	1001203
5x16 RE	-J	20195908	1	23	276	1250	1.15	1.38	102	79	1.84	2.26	Eca	1001203
5x25 RM	-J	20195923	1.2	29	348	1950	0.727	0.87	133	106	2.87	3.18	Eca	1001203
5x35 RM	-J	20195924	1.2	31	372	2450	0.524	0.627	159	129	4.03	3.69	Eca	1001203
5x50 RM	-J	20195925	1.4	37	444	3300	0.387	0.463	188	157	5.75	5	Eca	1001203
7x1,5 RE	-J	20195956	0.8	14	168	390	12.1	14.5	27	19.5	0.173	1.07	Eca	1001203
7x2,5 RE	-J	20195949	0.8	16	192	510	7.41	8.87	36	25	0.287	1.21	Eca	1001203
7x4 RE	-J	20195950	1	18	216	720	4.61	5.52	47	34	0.46	1.63	Eca	1001203
7x6 RE	-O	20195969	1	20	240	780	3.08	3.69	59	43	0.69	1.81	Eca	1001203
10x1,5 RE	-J	20195951	0.8	17	204	460	12.1	14.5	27	19.5	0.173	1.51	Eca	1001203
10x2,5 RE	-O	20195970	0.8	19	228	590	7.41	8.87	36	25	0.287	1.74	Eca	1001203
12x1,5 RE	-J	20195952	0.8	18	216	490	12.1	14.5	27	19.5	0.173	1.61	Eca	1001203
12x2,5 RE	-J	20195953	0.8	20	240	660	7.41	8.87	36	25	0.287	1.85	Eca	1001203
14x1,5 RE	-J	20195954	0.8	19	228	550	12.1	14.5	27	19.5	0.173	1.75	Eca	1001203
19x1,5 RE	-J	20195955	0.8	20	240	670	12.1	14.5	27	19.5	0.173	2.09	Eca	1001203
21x1,5 RE	-J	20196050	0.8	21	252	720	12.1	14.5	27	19.5	0.173	2.29	Eca	1001203
24x1,5 RE	-J	20195943	0.8	23	276	810	12.1	14.5	27	19.5	0.173	2.7	Eca	1001203
24x2,5 RE	-J	20195944	0.8	26	312	1150	7.41	8.87	36	25	0.287	3.14	Eca	1001203
30x1,5 RE	-J	20195945	0.8	25	300	930	12.1	14.5	27	19.5	0.173	3.01	Eca	1001203
30x2,5 RE	-J	20195946	0.8	27	324	1370	7.41	8.87	36	25	0.287	3.5	Eca	1001203
40x1,5 RE	-J	20196051	0.8	27	324	1170	12.1	14.5	27	19.5	0.173	3.71	Eca	1001203
40x2,5 RE	-J	20195966	0.8	30	360	1800	7.41	8.87	36	25	0.287	4.41	Eca	1001203

(1) Ground temperature 20°C; laying depth 0,7 m; thermal resistivity of the soil 1,0 Km/W (in case of partial drying out of the soil 2,5 Km/W); Load factor 0,7

(2) Air temperature 30 °C; Load factor 1,0

# Notes

---

---

---

---

---

---

---

---

---

---

---

---

---

---

---

---

---

---

---

---

---

---

---

---

---

---

---

---

---

## PROTODUR NAYY 0,6/1 kV CPR Eca



### Application

Distribution cables in supply networks. Connection cables inside wind power stations  
Laying: directly in ground, in tubes, free in air, indoors, in concrete and in water  
Lead-free, UV-resistant

### Global data

Brand	PROTODUR
Type designation	NAYY
Standard	DIN VDE 0276-603 Based on IEC 60502-1
Construction product regulation (CPR)	CPR acc. to DIN EN 50575, class and DoP code see data table below, DoP see <a href="http://www.prysmiangroup.com/cpr">www.prysmiangroup.com/cpr</a>

### Design features

Conductor	acc. to DIN EN 60228 solid circular (RE), class 1 or stranded circular, compacted (RM), class 2 or solid sector shaped (SE), class 1 or stranded sector shaped (SM), class 2
Insulation	Polyvinylchloride (PVC)
Core identification	Colours of cores acc. to DIN VDE 0293-308 1 core: NAYY-O black 4 cores: NAYY-O blue, brown, black, grey; NAYY-J green/yellow, brown, black, grey 5 cores: NAYY-J green/yellow, blue, brown, black, grey
Inner covering	Extruded or lapped (except for single core cables)
Outer sheath	flame retardant fleece
Outer sheath	AFUMEX SPECIAL-sheath
Outer sheath colour	Black

### Electrical parameters

Rated voltage	0.6/1 kV (600/1000V)
Max. permissible operating voltage AC	1.2 kV
Max. permissible operating voltage DC	1.8 kV

### Chemical parameters

Reaction to fire	DIN EN 60332-1-2
------------------	------------------

### Thermal parameters

Max. permissible temperature at conductor	70 °C
Max. short circuit temperature of the conductor	160 °C ≤ 300mm <sup>2</sup> 140 °C ≥ 300mm <sup>2</sup>
Laying temperature min.	-5 °C

PROTODUR NAYY 0,6/1 kV CPR Eca

Number of cores x cross section	Art. Des. O/J	Part number	Outer diameter nom. mm	Weight (approx.) kg/km	Conductor resistance at 20°C max. Ω/km	AC resistance at max. conductor temp. Ω/km	Inductance nom. mH/km	Current-carrying capacity for installat. in air, trefoil (1) A	Current-carrying capacity for installat. in air, flat spaced (2) A	Current-carrying capacity during normal operation, laid in the ground (1) A	Current carrying capacity free in air (2) A	Short Circuit Current (conductor) max. (1s) kA	CPR fire class	CPR DoP-Code
1x50 RM	-O	20001623	15	310	0.641	0.77	0.325	131	162			3.8	Eca	1004357
1x70 RM	-O	20001624	17	390	0.443	0.533	0.309	166	204			5.32	Eca	1004357
1x95 RM	-O	20001625	19	510	0.32	0.385	0.302	205	251			7.22	Eca	1004357
1x120 RM	-O	20001626	20	600	0.253	0.305	0.294	239	293			9.12	Eca	1004357
1x150 RM	-O	20001627	21	720	0.206	0.248	0.291	273	335			11.4	Eca	1004357
1x185 RM	-O	20001628	24	870	0.164	0.197	0.287	317	388			14.1	Eca	1004357
1x240 RM	-O	20001629	27	1100	0.125	0.15	0.282	378	463			18.2	Eca	1004357
1x300 RM	-O	20001630	30	1350	0.1	0.12	0.28	437	536			22.8	Eca	1004357
1x400 RM	-O	20001631	33	1700	0.0778	0.0935	0.276	513	629			27.2	Eca	1004357
1x500 RM	-O	20001632	37	2100	0.0605	0.0727	0.273	600	739			34	Eca	1004357
1x630 RM	-O	20001633	41	2600	0.0469	0.0564	0.267	701	870			42.8	Eca	1004357
4x25 RE	-O	20235928	25	950	1.2	1.44	0.283			102	82	1.9	Eca	1004354
4x35 RE	-O	20086580	27	1150	0.868	1.04	0.274			123	100	2.66	Eca	1004354
4x50 SE	-O		29	1250	0.641	0.77	0.271			144	119	3.8	Eca	1004354
4x70 SE	-O		33	1700	0.443	0.533	0.262			179	152	5.32	Eca	1004355
4x95 SE	-O	20001635	37	2150	0.32	0.385	0.261			215	186	7.22	Eca	1004355
4x120 SE	-O		41	2650	0.253	0.305	0.256			245	216	9.12	Eca	1004355
4x150 SE	-O		45	3100	0.206	0.248	0.257			275	246	11.4	Eca	1004355
4x185 SE	-O	20001636	50	3850	0.164	0.198	0.256			313	285	14.1	Eca	1004355
4x25 RE	-J	20001637	25	950	1.2	1.44	0.283			102	82	1.9	Eca	1004354
4x35 RE	-J	20001643	27	1150	0.868	1.04	0.274			123	100	2.66	Eca	1004354
4x50 SE	-J	20090088	29	1250	0.641	0.77	0.271			144	119	3.8	Eca	1004355
4x70 SE	-J	20001651	33	1700	0.443	0.533	0.262			179	152	5.32	Eca	1004355
4x95 SE	-J	20001656	37	2150	0.32	0.385	0.261			215	186	7.22	Eca	1004355
4x120 SE	-J	20001657	41	2650	0.253	0.305	0.256			245	216	9.12	Eca	1004355
4x150 SE	-J	20090089	45	3100	0.206	0.248	0.257			275	246	11.4	Eca	1004355
4x185 SE	-J	20090090	50	3850	0.164	0.198	0.256			313	285	14.1	Eca	1004355
4x240 SE	-J	20040214	55	4800	0.125	0.152	0.255			364	338	18.2	Eca	1004355
4x240 SM	-J	20001647	59	4950	0.125	0.152	0.255			364	338	18.2	Eca	1004355
5x95 RM	-J	20025442	48	3500	0.32	0.385	0.261			215	186	7.22	Eca	1004354

(1) bundled: center distance: 1x cables diameter (2) side by side: center distance: 2x cables diameter  
 (1) Ground temperature 20°C; laying depth 0,7 m; thermal resistivity of the soil 1,0 Km/W (in case of partial drying out of the soil 2,5 Km/W); Load factor 0,7 (2) Air temperature 30 °C; Load factor 1,0

## TOWERFLEX GLOBAL EMC LSOH 3GCSGHXOEU-K 1,8/3 kV



## Application

These cables are intended for fixed installations in wind turbines in cases where improved flexibility and very good bending behaviour is required.

## Global data

Brand	TOWERFLEX GLOBAL EMC LSOH
Type designation	3GCSGHXOEU-K
Standard	Based on IEC 60502-1

## Design features

Conductor	Copper bare, stranded wire class 5 acc. to IEC 60228 / DIN EN 60228
Insulation	Rubber, compound type EPR acc. to IEC 60502-1
Inner sheath	Rubber, compound type GM1b, acc. to DIN VDE 0207 part 21
Screen over inner sheath	Braid of tinned copper wires, optical covering > 85 % Lapping with rubberized textile tape
Outer sheath	Rubber, compound type HXM1 acc. to DIN VDE 0266
Outer sheath colour	Black

## Electrical parameters

Rated voltage	1.8/3 kV
Max. permissible operating voltage AC	3.6 kV

## Chemical parameters

Smoke emission	DIN EN 61034-2
Flame propagation	DIN EN 60332-1-2
Resistance to oil	DIN EN 60811-404
UV-resistance	Cable is UV-resistant
Ozone resistance	DIN EN 60811-403 IEC 60811-403

## Thermal parameters

Max. permissible temperature at conductor	90 °C
Max. short circuit temperature of the conductor	250 °C
Ambient temperature for fix installation min.	-40 °C

## Mechanical parameters

Max. tensile load on the conductor	15 N/mm <sup>2</sup>
Min. bending radius	Acc. to DIN VDE 0298 part 3

Number of cores x cross section	Conductor diameter max. mm	Insulation thickness nom. mm	Outer Sheath Thickness nom. mm	Outer diameter min. mm	Outer diameter max. mm	Weight (approx.) kg/km	Permissible tensile force max. N	Conductor resistance at 20°C max. Ω/km	AC resistance at max. conductor temp. Ω/km	Nominal operating capacitance μF/km	Inductive Reactance (at 50Hz) Ω/km	Inductive Reactance (at 60Hz) Ω/km	Current carrying capacity (1) A	Short Circuit Current (conductor) kA
3x150/25	16.2	2	2.3	50	55	6410	6750	0.129	0.164	0.36	0.073	0.088	399	21.5



## TOWERFLEX-AS GLOBAL A3GSGHOEU-R 1,8/3 kV



## Application

These cables are intended for use in wind turbines, suitable for fixed installation at medium mechanical stress.

## Global data

Brand	TOWERFLEX-AS GLOBAL
Type designation	A3GSGHOEU-R
Standard	Based on IEC 60502-1

## Design features

Conductor	Aluminium, stranded wire class 2, soft annealed, acc. to IEC 60228 / DIN EN 60228
Insulation	Rubber, compound type HEPR acc. to IEC 60502-1
Core identification	acc. to HD 308
Outer sheath	Rubber, compound type 5GM3 acc. to DIN VDE 0207 Part 21
Outer sheath colour	Black

## Electrical parameters

Rated voltage	1.8/3 kV
Max. permissible operating voltage AC	3.6 kV

## Chemical parameters

Flame propagation	DIN EN 60332-1-2
Resistance to oil	DIN EN 60811-404
UV-resistance	Cable is UV-resistant
Ozone resistance	DIN EN 60811-403 IEC 60811-403

## Thermal parameters

Max. permissible temperature at conductor	90 °C
Max. short circuit temperature of the conductor	250 °C
Ambient temperature for fix installation min.	-40 °C

## Mechanical parameters

Max. tensile load on the conductor	30 N/mm <sup>2</sup>
Min. bending radius	Acc. to DIN VDE 0298 part 3

Number of cores x cross section	Conductor diameter max. mm	Insulation thickness nom. mm	Outer Sheath Thickness nom. mm	Outer diameter min. mm	Outer diameter max. mm	Bending radius fixed min. mm	Weight (approx.) kg/km	Permissible tensile force max. N	Conductor resistance at 20°C max. Ω/km	AC resistance at max. conductor temp. Ω/km	Inductive Reactance (at 50Hz) Ω/km	Current carrying capacity (1) A	Short Circuit Current (conductor) kA
1x185	16	2	1.7	22	25	150	824	5550	0.164	0.209	0.083	395	17.4
1x240	18.1	2	1.8	24	27	162	1015	7200	0.125	0.16	0.082	471	22.6

## TOWERFLEX-AS GLOBAL OR A3GSGHOEU-R 1,8/3 kV

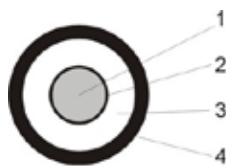

## Application

These cables are intended for fixed installations in wind turbines with special requirements on partial discharge resistance.

## Global data

Brand	TOWERFLEX-AS GLOBAL OR
Type designation	A3GSGHOEU-R
Standard	Based on IEC 60502-1

## Design features

Conductor	Aluminium, stranded wire class 2, soft annealed, acc. to IEC 60228 / DIN EN 60228
Insulation	Rubber, compound type HEPR acc. to IEC 60502-1
Electrical field control	Inner layer of semiconductive rubber compound
Core identification	acc. to HD 308
Outer sheath	Rubber, compound type 5GM3 acc. to DIN VDE 0207 Part 21
Outer sheath colour	Black

## Electrical parameters

Rated voltage	1.8/3 kV
Max. permissible operating voltage AC	3.6 kV

## Chemical parameters

Flame propagation	DIN EN 60332-1-2
Resistance to oil	DIN EN 60811-404
UV-resistance	Cable is UV-resistant
Ozone resistance	DIN EN 60811-403 IEC 60811-403

## Thermal parameters

Max. permissible temperature at conductor	90 °C
Max. short circuit temperature of the conductor	250 °C
Ambient temperature for fix installation min.	-40 °C

## Mechanical parameters

Max. tensile load on the conductor	30 N/mm <sup>2</sup>
Min. bending radius	Acc. to DIN VDE 0298 part 3

Number of cores x cross section	Conductor diameter max. mm	Insulation thickness nom. mm	Outer Sheath Thickness nom. mm	Outer diameter min. mm	Outer diameter max. mm	Bending radius fixed min. mm	Weight (approx.) kg/km	Permissible tensile force max. N	Conductor resistance at 20°C max. Ω/km	AC resistance at max. conductor temp. Ω/km	Inductive Reactance (at 50Hz) Ω/km	Current carrying capacity (1) A	Short Circuit Current (conductor) kA
1x150	14.3	2	1.7	22	25	150	685	4500	0.206	0.263	0.089	343	14.1
1x185	16	2	1.7	23	26	156	845	5550	0.164	0.209	0.086	395	17.4
1x240	18.1	2	1.8	25	28	168	1055	7200	0.125	0.16	0.084	471	22.6

## TOWERFLEX GLOBAL EMC 3GDSGHOEU-K 1,8/3 kV



## Application

These cables are intended for use in wind turbines, suitable for fixed installation at medium mechanical stress. For system design planning, dimensioning of conductor cross-section, current-carrying capacities and reference methods of installation, as well as applicable correction factors, the specific data of IEC 60364-5-52 have to be considered.

## Global data

Brand	TOWERFLEX GLOBAL EMC
Type designation	3GDSGHOEU-K
Standard	Based on IEC 60502-1

## Design features

Conductor	Copper bare, stranded wire class 5 acc. to IEC 60228 / DIN EN 60228
Insulation	Rubber, compound type EPR acc. to IEC 60502-1
Screen	Aluminium laminated foil with spinning of tinned copper wires covering > 90 %
Outer sheath	Rubber, compound type 5GM3 acc. to DIN VDE 0207 Part 21
Outer sheath colour	Black

## Electrical parameters

Rated voltage	1.8/3 kV
Max. permissible operating voltage AC	2.1/3.6 kV
Max. permissible operating voltage DC	2.7/5.4 kV

## Chemical parameters

Flame propagation	DIN EN 60332-1-2
Resistance to oil	DIN EN 60811-404
UV-resistance	Cable is UV-resistant
Ozone resistance	DIN EN 60811-403 IEC 60811-403

## Thermal parameters

Max. permissible temperature at conductor	90 °C
Max. short circuit temperature of the conductor	250 °C
Ambient temperature for fix installation min.	-40 °C

## Mechanical parameters

Max. tensile load on the conductor	15 N/mm <sup>2</sup>
------------------------------------	----------------------

Number of cores x cross section	Part number	Conductor diameter max. mm	Insulation thickness nom. mm	Outer Sheath Thickness nom. mm	Outer diameter min. mm	Outer diameter max. mm	Bending radius fixed min. mm	Weight (approx.) kg/km	Permissible tensile force max. N	Conductor resistance at 20°C max. Ω/km	Current carrying capacity (1) A	Short Circuit Current (conductor) kA
1x240	20170732	20.3	2.4	1.9	29.5	31.5	130	2610	3600	0.0801	541	34.3

## WINDFLEX (N)TMHXOEU 1,8/3 kV

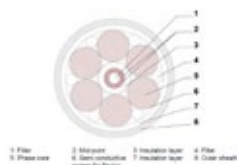

## Application

These cables are intended for use at medium mechanical stresses in wind turbines.

## Global data

Brand	WINDFLEX
Type designation	(N)TMHXOEU
Standard	Based on DIN VDE 0250-813

## Design features

Conductor	bare copper, fine wire class 5 according to IEC 60228 / DIN EN 60228.
Insulation	Rubber, compound type EPR acc.to IEC 60502-1 Wall thickness nominal Core = 3,4mm Wall thickness nominal Ground = 2,0mm
Outer sheath	Vulcanized rubber compound, compound HXM1 in accordance with DIN VDE 0266,
Outer sheath colour	Black

## Electrical parameters

Rated voltage	1.8/3 kV
Max. permissible operating voltage AC	2.1/3.6 kV
Max. permissible operating voltage DC	2.7/5.4 kV
AC test voltage	6,5 kV

## Chemical parameters

resistance to cooling fluid	acc. to IEC 60811-404 - Dowcal10 (50%Ethylenglycol) 24h at 60° - Havoline XLC+B-40 (50%Ethylenglycol) 24h at 60°
Reaction to fire	acc. to IEC 60332-1-2 (DIN EN 60332-1-2)
Flame propagation	IEC 60332-1-2
Resistance to oil	acc. to IEC 60811-404 24h at 100 °C - IRM 902 - Cognis Breox SL 320 - Mobilgear SHC XMP 320 - Shell Tivela SC 320 - Texaco Meropa 320 - Texaco Pinnacle WM 320 - Tribol 1710/320 - Mobil SHC 524 - Mobil Aero HF(A) 32 - Texaco Rando HDZ LT 32 - Texaco Rando WM 32 - Shell Transaxle 75W-90
UV-resistance	Cable is UV-resistant
Ozone resistance	DIN EN 60811-403 IEC 60811-403

## Thermal parameters

Max. permissible temperature at conductor	90 °C
Max. short circuit temperature of the conductor	250 °C
Ambient temperature for fix installation min.	-40 °C
Ambient temperature for fix installation max.	80 °C
Ambient temp. in fully flex. operation min.	-25 °C
Ambient temp. in fully flex. operation max.	80 °C

## WINDFLEX (N)TMHXOEU 1,8/3 kV

---

**Mechanical parameters**

Max. tensile load on the conductor	15 N/mm <sup>2</sup>
Torsional stress +/-	100 °/m
Min. bending radius	moving: 10 X D; fixed: 6 X D

---

Number of cores x cross section	Part number	Conductor diameter max. mm	Outer Sheath Thickness nom. mm	Outer diameter min. mm	Outer diameter max. mm	Bending radius fixed min. mm	Bending radius free moving min. mm	Weight (approx.) kg/km	Permissible tensile force max. N
6x240+1x120mm <sup>2</sup>	20180878	20.2	4.5	77	80	483	805	15920	21600

## PROTOTHEN-X NA2XS(FL)2Y 6/10 kV CPR Fca



### Application

Distribution cables in supply networks

The cables are suitable to be laid direct burial, in ducts, in water, outdoor above ground and indoor.

In open air, indoors and in ducts: non flame retardant according DIN EN 60332-1-2.

The Al/PE laminated sheath acts as a vapour barrier in radial direction. The ingress of water in case of a damaged outer sheath is limited by the longitudinal watertight screen area.

The aluminium tape is in direct contact to the copper screen and need not to be connected during jointing.

### Global data

Brand	PROTOTHEN-X
Type designation	NA2XS(FL)2Y
Standard	IEC 60502-2 DIN VDE 0276-620
Construction product regulation (CPR)	CPR acc. to DIN EN 50575, class DoP code see data table below, DoP see <a href="http://www.prysmiangroup.com/cpr">www.prysmiangroup.com/cpr</a>



### Design features

Insulation	cross-linked polyethylene (XLPE)
Electrical field control	Inner and outer semi-conductive layer of XLPE, tough bonded to the insulation
Radially watertight	PE laminated, firmly bonded to the sheath
Separator under screen	Semi-conducting swelling tape
Screen	Copper wires with helix copper tape
Outer sheath	Polyethylene (PE)
Outer sheath colour	Black

### Electrical parameters

Rated voltage	6/10 kV
Max. permissible operating voltage AC	12 kV
AC test voltage	21 kV

### Thermal parameters

Max. permissible temperature at conductor	90 °C
Max. short circuit temperature of the conductor	250 °C
Laying temperature min.	-20 °C

### Mechanical parameters

Max. tensile load on the conductor	30 N/mm <sup>2</sup>
Min. bending radius	15 x D

## PROTOTHEN-X NA2XS(FL)2Y 6/10 kV CPR Fca

Number of cores x cross section	Part number	Outer diameter nom. mm	Bending radius fixed min. mm	Weight (approx.) kg/km	Conductor resistance at 20°C max. Ω/km	AC resistance at max. conductor temp. Ω/km	Nominal operating capacitance μF/km	Inductance nom. mH/km	Current-carrying capacity during normal operation, laid in the ground (1) A	Current carrying capacity free in air (2) A	Short Circuit Current (Screen) kA	Short Circuit Current (conductor) kA	CPR fire class	CPR DoP-Code
1x50 RM/16	20056531	25	375	700	0.641	0.827	0.243	0.428	171	183	3.3	4.7	Fca	1004336
1x70 RM/16		28	420	790	0.443	0.573	0.275	0.405	208	228	3.3	6.58	Fca	1004336
1x95 RM/16	20002493	29	435	900	0.32	0.415	0.309	0.386	248	278	3.3	8.93	Fca	1004336
1x120 RM/16		30	450	1000	0.253	0.33	0.339	0.372	283	321	3.3	11.3	Fca	1004336
1x150 RM/25	20002494	31	465	1200	0.206	0.271	0.367	0.36	315	364	5.1	14.1	Fca	1004336
1x185 RM/25		33	495	1300	0.164	0.217	0.4	0.348	357	418	5.1	17.4	Fca	1004336
1x240 RM/25	20002495	35	525	1500	0.125	0.168	0.446	0.335	413	494	5.1	22.6	Fca	1004336
1x300 RM/25	20069916	38	570	1750	0.1	0.136	0.489	0.325	466	568	5.1	28.2	Fca	1004336
1x400 RM/35	20096441	41	615	2150	0.0778	0.109	0.542	0.314	529	660	7.1	37.6	Fca	1004336
1x500 RM/35	20002498	43	645	2450	0.0605	0.0878	0.603	0.305	602	767	7.1	47	Fca	1004336
1x630 RM/35		48	720	2950	0.0469	0.0713	0.674	0.296	683	889	7.1	59.2	Fca	1004336

(1) Ground temperature 20 °C; laying depth 0,7 m; soil thermal resistivity 1,0 Km/W (desiccated soil 2,5 Km/W); load factor 0,7 (2) Air temperature 30 °C; load factor 1,0  
Closed trefoil formation, copper screens bonded at both ends.



## WINDFLEX LSOH (N)TMCHXOEU 12/20 kV



## Application

These cables are intended for use at medium mechanical stresses in wind turbines.

## Global data

Brand	WINDFLEX LSOH
Type designation	(N)TMCHXOEU
Standard	DIN VDE 0250-813

## Design features

Conductor	bare copper, fine wire class 5 according to IEC 60228 / DIN EN 60228.
Insulation	Rubber, compound type EPR-3GI3
Electrical field control	Inner and outer layer of semiconductive rubber compound
Core identification	acc. to DIN VDE 0250 P 813 colours: nature
Screen	spiral of tinned copper wires
Outer sheath	Vulcanized rubber compound, compound HXM1 in accordance with DIN VDE 0266,
Outer sheath colour	Black

## Electrical parameters

Rated voltage	12/20 kV
Max. permissible operating voltage AC	13.9/24 kV
Max. permissible operating voltage DC	18/36 kV
AC test voltage	29 kV

## Chemical parameters

resistance to cooling fluid	acc. to IEC 60811-404 - Dowcal10 (50%Ethylenglycol) 24h at 60° - Havoline XLC+B-40 (50%Ethylenglycol) 24h at 60°
Reaction to fire	acc. to IEC 60332-1-2
Flame propagation	IEC 60332-1-2
Resistance to oil	acc. to EN 60811-404 24h at 100 °C - IRM 902 - Cognis Breox SL 320 - Mobilgear SHC XMP 320 - Shell Tivela SC 320 - Texaco Meropa 320 - Texaco Pinnacle WM 320 - Tribol 1710/320 - Mobil SHC 524 - Mobil Aero HF(A) 32 - Texaco Rando HDZ LT 32 - Texaco Rando WM 32 - Shell Transaxle 75W-90
UV-resistance	Cable is UV-resistant
Ozone resistance	DIN EN 50396 clause 8.1.3

## Thermal parameters

Max. permissible temperature at conductor	90 °C
Max. short circuit temperature of the conductor	250 °C
Ambient temperature for fix installation min.	-40 °C
Ambient temperature for fix installation max.	80 °C
Ambient temp. in fully flex. operation min.	-25 °C
Ambient temp. in fully flex. operation max.	80 °C

## Mechanical parameters

## WINDFLEX LSOH (N)TMCHXOEU 12/20 kV

Number of cores x cross section	Part number	Conductor diameter max. mm	Insulation thickness nom. mm	Diameter over insulation (nom.) mm	Outer Sheath Thickness nom. mm	Outer diameter min. mm	Outer diameter max. mm	Bending radius free moving min. mm	Weight (approx.) kg/km	Conductor resistance at 20°C max. Ω/km	Nominal operating capacitance μF/km	Current carrying capacity (1) A	Short Circuit Current (conductor) max. (1s) kA
1 x 50/16	20161469	9.3	5.5		2.5	27	30	300	1440	0.386	0.24	275	7.15
1 x 120/16		14.8	5.5	28.4	2.5	36.4	38.9	389	21502350	0.164	0.28	505	17.16
1 x 150/25	20231822	16	5.5	30.1	2.5	36	40	414	2730	0.132	0.29	582	21.45

(1) Three loaded conductors, spaced

## WINDFLEX (N)TSCGEHXOEU 12/20 kV



## Application

These halogen-free medium voltage cables are intended for use in wind turbines with medium mechanical effort in a temperature range from -40°C to +90°C. The cables can be installed free moveable, free hanging or fixed. For free hanging operation the cables are twistable. The cables are used for economic power transmission of large energy rates with medium voltage. In other respects DIN VDE 0250 applies.

## Global data

Brand	WINDFLEX
Type designation	(N)TSCGEHXOEU
Standard	DIN VDE 0250-813

## Design features

Conductor	Electrolytic bare copper, finely stranded, Class 5 according to DIN VDE 0295 / IEC 60228
Insulation	Halogenfree, heat resistant insulation HEPR acc. to IEC 60840, super clean
Electrical field control	Inner and outer layer of semiconductive rubber compound
Core identification	Natural colouring with black semiconductive rubber
Inner sheath	Rubber, compound type GM1b, halogen free, acc. to DIN VDE 0207 part 21
Outer sheath	Halogenfree compound HXM1 acc. to VDE 0266
Outer sheath colour	Black

## Electrical parameters

Rated voltage	12/20 kV
Max. permissible operating voltage AC	13.9/24 kV
Max. permissible operating voltage DC	18/36 kV
AC test voltage - main cores	30 kV (5 Min.)

## Chemical parameters

resistance to cooling fluid	acc. to IEC 60811-2-1 24h at 60°C - Dowcal 10 (50% Ethylenglycol) - Havoline XLC +B -40 (50% Ethylenglycol)
Smoke emission	DIN EN 61034-2
Flame propagation	DIN EN 60332-1-2
Resistance to oil	acc. to IEC 60811-404 24h at 100°C - IRM 902 - Cognis Breox SL 320 - Mobilgear SHC XMP 320 - Shell Tivela SC 320 - Texaco Meropa 320 - Texaco Pinnacle WM 320 - Tribol 1710/320 - Mobil SHC 524 - Mobil Aero HF(A) 32 - Texaco Rando HDZ LT 32 - Texaco Rando WM 32 - Shell Transaxle 75W-90
UV-resistance	Cable is UV-resistant
Ozone resistance	DIN EN 50396 clause 8.1.3

## Thermal parameters

Max. permissible temperature at conductor	90 °C
Max. short circuit temperature of the conductor	250 °C
Ambient temperature for fix installation min.	-40 °C
Ambient temperature for fix installation max.	80 °C
Ambient temp. in fully flex. operation min.	-40 °C
Ambient temp. in fully flex. operation max.	80 °C

## WINDFLEX (N)TSCGEHXOEU 12/20 kV

### Mechanical parameters

Max. tensile load on the conductor	15 N/mm <sup>2</sup>
Torsional stress +/-	100 °/m
Min. bending radius	Acc. to DIN VDE 0298 part 3

Number of cores x cross section	Part number	Conductor diameter max. mm	Outer Sheath Thickness nom. mm	Outer diameter min. mm	Outer diameter max. mm	Bending radius free moving min. mm	Weight (approx.) kg/km	Conductor resistance at 20°C max. Ω/km	Inductive Reactance (at 50Hz) Ω/km	Inductive Reactance (at 60Hz) Ω/km	Current carrying capacity (1) A	Short Circuit Current (conductor) kA
3x25/25	20175098	6.2	4.1	47.3	49.5	495	3880	0.78	0.118	0.142	127	3.58
3x70/70	20088533	11.1	6.4	58	62	670	5520	0.272	0.099	0.118	246	10

Current carrying capacity free in air at 30°C acc. to IEC 60364-5-52T B52.12

## WINDFLEX (N)TSCGEHXOEU 12/20 kV



## Application

These halogen-free medium voltage cables are intended for use in wind turbines with medium mechanical stress in a temperature range from -40°C to +90°C. The cables can be installed free moveable, free hanging or fixed. For free hanging operation the cables are twistable. The cables are used for economic power transmission of large energy rates with medium voltage. In other respects DIN VDE 0250 applies.

## Global data

Brand	WINDFLEX
Type designation	(N)TSCGEHXOEU
Standard	DIN VDE 0250-813 IEC 60502-2 IEC 60840

## Design features

Conductor	Electrolytic bare copper, finely stranded, Class 5 according to DIN VDE 0295 / IEC 60228
Insulation	Halogenfree, heat resistant insulation HEPR acc. to IEC 60840, super clean
Electrical field control	Inner and outer layer of semiconductive rubber compound
Core identification	Natural colouring with black semiconductive rubber
Inner sheath	Rubber, compound type GM1b, halogen free, acc. to DIN VDE 0207 part 21
Outer sheath	Halogenfree compound HXM1 acc. to VDE 0266
Outer sheath colour	Black

## Electrical parameters

Rated voltage	12/20 kV
Max. permissible operating voltage AC	13.9/24 kV
Max. permissible operating voltage DC	18/36 kV
AC test voltage - main cores	30 kV (5 Min.)

## Chemical parameters

resistance to cooling fluid	acc. to IEC 60811-404 24h at 60°C - Dowcal 10 (50% Ethylenglycol) - Havoline XLC +B -40 (50% Ethylenglycol)
Smoke emission	IEC 61034-2
Flame propagation	IEC 60332-1-2
Resistance to oil	acc. to IEC 60811-404 24h at 100°C - IRM 902 - Cognis Breox SL 320 - Mobilgear SHC XMP 320 - Shell Tivela SC 320 - Texaco Meropa 320 - Texaco Pinnacle WM 320 - Tribol 1710/320 - Mobil SHC 524 - Mobil Aero HF(A) 32 - Texaco Rando HDZ LT 32 - Texaco Rando WM 32 - Shell Transaxle 75W-90
UV-resistance	Cable is UV-resistant
Ozone resistance	DIN EN 50396 clause 8.1.3

## Thermal parameters

Max. permissible temperature at conductor	90 °C
Max. short circuit temperature of the conductor	250 °C
Ambient temp. in fully flex. operation min.	-40 °C
Ambient temp. in fully flex. operation max.	80 °C

## WINDFLEX (N)TSCGEHXOEU 12/20 kV

## Mechanical parameters

Max. tensile load on the conductor	15 N/mm <sup>2</sup>
Torsional stress +/-	100 °/m
Min. bending radius	Acc. to DIN VDE 0298 part 3

Number of cores x cross section	Part number	Conductor diameter max. mm	Insulation thickness nom. mm	Outer Sheath Thickness nom. mm	Outer diameter min. mm	Outer diameter max. mm	Bending radius free moving min. mm	Weight (approx.) kg/km	Conductor resistance at 20°C max. Ω/km	Nominal operating capacitance μF/km	Inductive Reactance (at 50Hz) Ω/km	Inductive Reactance (at 60Hz) Ω/km	Current carrying capacity (1) A	Short Circuit Current (conductor) kA
3x50+3x50/3	20196721	9.6	3.6	3	50.5	53.5	535	4090	0.386	0.293	0.103	0.124	192	7.15
3x70+3x70/3	20176474	11.1	3.6	3	58	61	610	5470	0.272	0.326	0.099	0.118	246	10.01
3x95+3x95/3	20227280	12.6	3.6	3	58	61	720	5980	0.206	0.357	0.095	0.114	298	13.59

Current carrying capacity free in air at 30°C acc. to IEC 60364-5-52T B52.12

## PROTOTHEN-X NA2XS(FL)2Y 12/20 kV CPR Fca



### Application

Distribution cable in supply networks

The cables are suitable to be laid direct burial, in ducts, in water, outdoor above ground and indoor.

In open air, indoors and in ducts: non flame retardant according DIN EN 60332-1-2

The Al/PE laminated sheath acts as a vapour barrier in radial direction. The ingress of water in case of a damaged outer sheath is limited by the longitudinal watertight screen area.

The aluminium tape is in direct contact to the copper screen and need not to be connected during jointing.

### Global data

Brand	PROTOTHEN-X
Type designation	NA2XS(FL)2Y
Standard	DIN VDE 0276-620 IEC 60502-2
Construction product regulation (CPR)	CPR acc. to DIN EN 50575, class and DoP code see data table below, DoP see <a href="http://www.prysmiangroup.com/cpr">www.prysmiangroup.com/cpr</a>



### Design features

Insulation	cross-linked polyethylene (XLPE)
Electrical field control	Inner and outer semi-conductive layer of XLPE, tough bonded to the insulation
Radially watertight	PE laminated, firmly bonded to the sheath
Separator under screen	Semi-conducting swelling tape
Screen	Copper wires with helix copper tape
Outer sheath	Polyethylen (PE)
Outer sheath colour	Black

### Electrical parameters

Rated voltage	12/20 kV
Max. permissible operating voltage AC	24 kV
AC test voltage	42 kV

### Thermal parameters

Max. permissible temperature at conductor	90 °C
Max. short circuit temperature of the conductor	250 °C
Laying temperature min.	-20 °C

### Mechanical parameters

Max. tensile load on the conductor	30 N/mm <sup>2</sup>
Min. bending radius	15 x D



## PROTOTHEN-X NA2XS(FL)2Y 12/20 kV CPR Fca

Number of cores x cross section	Part number	Outer diameter nom. mm	Bending radius fixed min. mm	Weight (approx.) kg/km	Conductor resistance at 20°C max. Ω/km	AC resistance at max. conductor temp. Ω/km	Nominal operating capacitance μF/km	Inductance nom. mH/km	Current-carrying capacity during normal operation, laid in the ground (1) A	Current carrying capacity free in air (2) A	Short Circuit Current (Screen) kA	Short Circuit Current (conductor) kA	CPR fire class	CPR DoP-Code
1x50 RM/16		30	450	900	0.641	0.827	0.171	0.46	172	185	3.3	4.7	Fca	1004337
1x70 RM/16		31	465	950	0.443	0.573	0.191	0.435	210	231	3.3	6.58	Fca	1004337
1x95 RM/16	20002664	33	495	1050	0.32	0.415	0.212	0.414	251	280	3.3	8.93	Fca	1004337
1x120 RM/16		34	510	1200	0.253	0.33	0.231	0.399	285	323	3.3	11.3	Fca	1004337
1x150 RM/25	20002665	35	525	1350	0.206	0.271	0.249	0.386	319	366	5.1	14.1	Fca	1004337
1x185 RM/25	20042532	37	555	1550	0.164	0.217	0.27	0.373	361	420	5.1	17.4	Fca	1004337
1x240 RM/25	20002667	39	585	1750	0.125	0.167	0.298	0.358	417	496	5.1	22.6	Fca	1004337
1x300 RM/25		42	630	1950	0.1	0.136	0.325	0.347	471	569	5.1	28.2	Fca	1004337
1x400 RM/35	20096770	45	675	2350	0.0778	0.109	0.358	0.336	535	660	7.1	37.6	Fca	1004337
1x500 RM/35		48	720	2750	0.0605	0.0876	0.396	0.324	609	766	7.1	47	Fca	1004337
1x630 RM/35	20181569	51	765	3250	0.0469	0.071	0.44	0.314	692	888	7.1	59.2	Fca	1004337

Closed trefoil formation, copper screens bonded at both ends.

(1) Ground temperature 20 °C; laying depth 0,7 m; soil thermal resistivity 1,0 Km/W (desiccated soil 2,5 Km/W); load factor 0,7 (2) Air temperature 30 °C; load factor 1,0

## PROTOTHEN-X NA2XS(FL)2Y 18/30 kV CPR Fca



### Application

Distribution cable in supply networks

The cables are suitable to be laid direct burial, in ducts, in water, outdoor above ground and indoor.

In open air, indoors and in ducts: non flame retardant according DIN EN 60332-1-2

The Al/PE laminated sheath acts as a vapour barrier in radial direction. The ingress of water in case of a damaged outer sheath is limited by the longitudinal watertight screen area.

The aluminium tape is in direct contact to the copper screen and need not to be connected during jointing.

### Global data

Brand	PROTOTHEN-X
Type designation	NA2XS(FL)2Y
Standard	DIN VDE 0276-620 IEC 60502-2
Construction product regulation (CPR)	CPR acc. to DIN EN 50575, class and DoP code see data table below, DoP see <a href="http://www.prysmiangroup.com/cpr">www.prysmiangroup.com/cpr</a>



### Design features

Insulation	cross-linked polyethylene (XLPE)
Electrical field control	Inner and outer semi-conductive layer of XLPE, tough bonded to the insulation
Radially watertight	PE laminated, firmly bonded to the sheath
Separator under screen	Semi-conducting swelling tape
Screen	Copper wires with helix copper tape
Outer sheath	Polyethylen (PE)
Outer sheath colour	Black

### Electrical parameters

Rated voltage	18/30 kV
Max. permissible operating voltage AC	36 kV
AC test voltage	63 kV

### Thermal parameters

Max. permissible temperature at conductor	90 °C
Max. short circuit temperature of the conductor	250 °C
Laying temperature min.	-20 °C

### Mechanical parameters

Max. tensile load on the conductor	30 N/mm <sup>2</sup>
Min. bending radius	15 x D

## PROTOTHEN-X NA2XS(FL)2Y 18/30 kV CPR Fca

Number of cores x cross section	Part number	Outer diameter nom. mm	Bending radius fixed min. mm	Weight (approx.) kg/km	Conductor resistance at 20°C max. Ω/km	AC resistance at max. conductor temp. Ω/km	Nominal operating capacitance μF/km	Inductance nom. mH/km	Current-carrying capacity during normal operation, laid in the ground (1) A	Current carrying capacity free in air (2) A	Short Circuit Current (Screen) kA	Short Circuit Current (conductor) kA	CPR fire class	CPR DoP-Code
1x50 RM/16		36	540	1150	0.641	0.827	0.133	0.493	174	187	3.3	4.7	Fca	1004338
1x70 RM/16		37	555	1250	0.443	0.573	0.148	0.466	213	232	3.3	6.58	Fca	1004338
1x95 RM/16		38	570	1400	0.32	0.415	0.163	0.443	254	282	3.3	8.93	Fca	1004338
1x120 RM/16		39	585	1500	0.253	0.33	0.176	0.427	289	325	3.3	11.3	Fca	1004338
1x150 RM/25		41	615	1650	0.206	0.271	0.188	0.413	322	367	5.1	14.1	Fca	1004338
1x185 RM/25		42	630	1800	0.164	0.217	0.203	0.399	364	421	5.1	17.4	Fca	1004338
1x240 RM/25	20002708	44	660	2000	0.125	0.167	0.223	0.383	422	496	5.1	22.6	Fca	1004338
1x300 RM/25	20097311	47	705	2300	0.1	0.136	0.241	0.37	476	568	5.1	28.2	Fca	1004338
1x400 RM/35	20007057	50	750	2750	0.0778	0.109	0.264	0.357	541	659	7.1	37.6	Fca	1004338
1x500 RM/35	20008760	53	795	3150	0.0605	0.0876	0.291	0.345	616	764	7.1	47	Fca	1004338
1x630 RM/35		57	855	3600	0.0469	0.0709	0.321	0.334	701	886	7.1	59.2	Fca	1004338

Closed trefoil formation, copper screens bonded at both ends.

(1) Ground temperature 20 °C; laying depth 0,7 m; soil thermal resistivity 1,0 Km/W (desiccated soil 2,5 Km/W); load factor 0,7 (2) Air temperature 30 °C; load factor 1,0

## WINDFLEX (N)TSCGEHXOEU 20/35 kV



## Application

These halogen-free medium voltage cables are intended for use in wind turbines with medium mechanical stress in a temperature range from -40°C to +90°C. The cables can be installed free moveable, free hanging or fixed. For free hanging operation the cables are twistable. The cables are used for economic power transmission of large energy rates with medium voltage. In other respects DIN VDE 0250 applies.

## Global data

Brand	WINDFLEX
Type designation	(N)TSCGEHXOEU
Standard	IEC 60840 IEC 60502-2 DIN VDE 0250-813

## Design features

Conductor	Electrolytic bare copper, finely stranded, Class 5 according to DIN VDE 0295 / IEC 60228
Insulation	Halogenfree, heat resistant insulation HEPR acc. to IEC 60840, super clean
Electrical field control	Inner and outer layer of semiconductive rubber compound
Core identification	Natural colouring with black semiconductive rubber
Inner sheath	Rubber, compound type GM1b, halogen free, acc. to DIN VDE 0207 part 21
Outer sheath	Halogenfree compound HXM1 acc. to VDE 0266
Outer sheath colour	Black

## Electrical parameters

Rated voltage	20/35 kV
Max. permissible operating voltage AC	24.2/42 kV
Max. permissible operating voltage DC	31.5/63 kV
AC test voltage - main cores	50 kV (5 Min.)

## Chemical parameters

resistance to cooling fluid	acc. to IEC 60811-2-1 24h at 60°C - Dowcal 10 (50% Ethylenglycol) - Havoline XLC +B -40 (50% Ethylenglycol)
Smoke emission	DIN EN 61034-2
Flame propagation	DIN EN 60332-1-2
Resistance to oil	acc. to IEC 60811-404 24h at 100°C - IRM 902 - Cognis Breox SL 320 - Mobilgear SHC XMP 320 - Shell Tivela SC 320 - Texaco Meropa 320 - Texaco Pinnacle WM 320 - Tribol 1710/320 - Mobil SHC 524 - Mobil Aero HF(A) 32 - Texaco Rando HDZ LT 32 - Texaco Rando WM 32 - Shell Transaxle 75W-90
UV-resistance	Cable is UV-resistant
Ozone resistance	DIN EN 50396 clause 8.1.3

## Thermal parameters

Max. permissible temperature at conductor	90 °C
Max. short circuit temperature of the conductor	250 °C
Ambient temp. in fully flex. operation min.	-40 °C
Ambient temp. in fully flex. operation max.	80 °C

## WINDFLEX (N)TSCGEHXOEU 20/35 kV

## Mechanical parameters

Max. tensile load on the conductor	15 N/mm <sup>2</sup>
Torsional stress +/-	100 °/m
Min. bending radius	Acc. to DIN VDE 0298 part 3

Number of cores x cross section	Part number	Conductor diameter max. mm	Insulation thickness nom. mm	Outer Sheath Thickness nom. mm	Outer diameter min. mm	Outer diameter max. mm	Bending radius free moving min. mm	Weight (approx.) kg/km	Conductor resistance at 20°C max. Ω/km	Nominal operating capacitance μF/km	Inductive Reactance (at 50Hz) Ω/km	Inductive Reactance (at 60Hz) Ω/km	Current carrying capacity (1) A	Short Circuit Current (conductor) kA
3x50+3x50/3	20196722	9.6	6.2	3.5	62.8	65.8	658	5440	0.386	0.196	0.118	0.141	192	7.15
3x70+3x70/3	20176475	11.1	6.2	3.5	67	70.8	708	6500	0.272	0.215	0.112	0.135	246	10
3x95+3x95/3	20222915	12.6	6.2	4	72.5	77	770	7840	0.206	0.234	0.108	0.130	298	13.59
3x120+3x120/3		14.4	6.2	4	76	79.5	795	9325	0.161	0.256	0.105	0.125	346	17.16
3x150+3x150/3	20224131	16	6.2	4	79	83.5	835	10620	0.129	0.276	0.101	0.121	399	21.45
3x185+3x185/3		17.7	6.2	4.5	84	89	890	11650	0.106	0.297	0.098	0.118	456	26.46
3x240+3x240/3		20.2	6.2	4.5	90	95	950	14695	0.0801	0.328	0.095	0.113	538	34.32

## WINDFLEX (N)TSCGEHXOEU 36/60-69 kV



### Application

These halogen-free high voltage cables are intended for use in wind turbines with medium mechanical effort in a temperature range from -40°C to +90°C. The cables can be installed free moveable, free hanging or fixed. For free hanging operation the cables are twistable. The cables are used for economic power transmission of large energy rates with high voltage. In other respects DIN VDE 0250 and IEC 60840 applies.

### Global data

Brand	WINDFLEX
Type designation	(N)TSCGEHXOEU
Standard	based on IEC 60840 Based on DIN VDE 0250-813

### Design features

Conductor	Electrolytic bare copper, finely stranded, Class 5 according to DIN VDE 0295 / IEC 60228
Insulation	Halogenfree, heat resistant insulation HEPR acc. to IEC 60840, super clean
Electrical field control	Inner and outer layer of semiconductive rubber compound
Core identification	Natural colouring with black semiconductive rubber
Inner sheath	Rubber, compound type GM1b, halogen free, acc. to DIN VDE 0207 part 21
Outer sheath	Halogenfree compound HXM1 acc. to VDE 0266
Outer sheath colour	Black

### Electrical parameters

Rated voltage	36/60-69 (72,5) kV
Max. permissible operating voltage AC	42/72.5 kV
Max. permissible operating voltage DC	54/108 kV
AC test voltage - main cores	90 kV (5 Min.)

### Chemical parameters

resistance to cooling fluid	acc. to IEC 60811-404 24h at 60°C - Dowcal 10 (50% Ethylenglycol) - Havoline XLC +B -40 (50% Ethylenglycol)
Smoke emission	IEC 61034-2
Flame propagation	IEC 60332-1-2
Resistance to oil	acc. to IEC 60811-404 24h at 100°C - IRM 902 - Cognis Breox SL 320 - Mobilgear SHC XMP 320 - Shell Tivela SC 320 - Texaco Meropa 320 - Texaco Pinnacle WM 320 - Tribol 1710/320 - Mobil SHC 524 - Mobil Aero HF(A) 32 - Texaco Rando HDZ LT 32 - Texaco Rando WM 32 - Shell Transaxle 75W-90
UV-resistance	Cable is UV-resistant
Ozone resistance	DIN EN 50396 clause 8.1.3

### Thermal parameters

Max. permissible temperature at conductor	90 °C
Max. short circuit temperature of the conductor	250 °C
Ambient temperature for fix installation min.	-40 °C
Ambient temperature for fix installation max.	80 °C
Ambient temp. in fully flex. operation min.	-40 °C
Ambient temp. in fully flex. operation max.	80 °C

## WINDFLEX (N)TSCGEHXOEU 36/60-69 kV

### Mechanical parameters

Max. tensile load on the conductor 15 N/mm<sup>2</sup>  
 Min. bending radius Acc. to DIN VDE 0298 part 3

Number of cores x cross section	Part number	Conductor diameter max. mm	Insulation thickness nom. mm	Outer Sheath Thickness nom. mm	Outer diameter min. mm	Outer diameter max. mm	Weight (approx.) kg/km	Conductor resistance at 20°C max. Ω/km	DC resistance at max. conductor temp. Ω/km	Nominal operating capacitance μF/km	Inductive Reactance (at 50Hz) Ω/km	Current carrying capacity (1) A	Short Circuit Current (conductor) kA	Torsional stress +/- °/m
3x95+3x95/3	20181086	12.5	10.5	4.5	92.6	96.5	11290	0.21		0.244		298	13.6	80
3x120+3x120/3		14.4	10.5	5	94	100	13015	0.153		0.268		346	17.4	70
3x150+3x150/3	20198294	16	10	5	96	104	14260	0.126	0.1607	0.292	0.1135	399	21.5	70
3x240+3x240/3		21.5	10	5	105	114	18555	0.0785		0.642		538	34.4	70

Bendingradius : fix 6xD, flex 10xD

Current carrying capacity free in air at 30°C acc. to IEC 60364-5-52T B52.12



## Feltoflex-RC (N)TMCHXOEU 36/60-69 kV



## Application

These cables are intended for use as flexible connection between offshore platforms as well as in switch-gears and transformers where very small bending radius and / or very low temperature is required, in dry or damp areas and outdoors. The flexibility of the cable allows operating equipment to be moved while running.

## Global data

Brand	FELTOFLEX-RC
Type designation	(N)TMCHXOEU
Standard	Based on DIN VDE 0250-813 Based on IEC 60840-2011
Certifications / Approvals	Typetest report KEMA TIC 3113-13

## Design features

Conductor	Bare copper, fine wire class 5 according to IEC 60228
Insulation	Rubber, compound type HEPR, Wall thickness and diameter see table
Electrical field control	Inner and outer layer of semiconductive rubber compound
Screen	Spiral of tinned copper wires
Outer sheath	Compound HXM1 acc. to DIN VDE 0266 Optional: Semiconductive layer above outer sheath
Outer sheath colour	Black (others colors on request)

## Electrical parameters

Rated voltage	U <sub>0</sub> /U 36/60-69 kV
Max. permissible operating voltage AC	72.5 kV
Duration of AC test voltage	30 min.
AC test voltage - main cores	90 kV (30 Min.)
AC test voltage	90 kV

## Chemical parameters

Toxicity of smoke	IEC 60754-2
Flame propagation	DIN EN 60332-1-2 DIN EN 60332-3-24
Resistance to oil	DIN EN 60811-404/ IEC 60811-404 IRM 902 - 24h bei 100 °C
UV-resistance	Cable is UV-resistant
Ozone resistance	DIN EN 60811-403 IEC 60811-403

## Thermal parameters

Max. permissible temperature at conductor	90 °C
Max. short circuit temperature of the conductor	250 °C
Ambient temperature for fixed installation	min -50 °C ; max +80 °C
Ambient temperature in fully flexible operation	min -40 °C ; max +80 °C

## Mechanical parameters

Max. tensile load on the conductor	15 N/mm <sup>2</sup>
Min. bending radius	moved min: 10 x D, fixed min. 5 x D, acc. to DIN VDE 0298 part 3. table 3

## Felftoflex-RC (N)TMCHXOEU 36/60-69 kV

Number of cores x cross section	Part number	Conductor diameter nom. mm	Insulation thickness nom. mm	Diameter over insulation (nom.) mm	Outer Sheath Thickness nom. mm	Outer diameter min. mm	Outer diameter max. mm	Outer diameter nom. mm	Weight (approx.) kg/km	Conductor resistance at 20°C max. Ω/km	Nominal operating capacitance μF/km	Current carrying capacity (1) A	Short Circuit Current (Screen) max. (1s) kA	Short Circuit Current (conductor) max. (1s) kA
1x25/16 KON		6.2	11	30.2	3.5	41.3	43.8	41.8	2067	0.78	0.128	160	3.2	3.6
1x35/16 KON		7.5	11	31.5	3.5	42.6	45.1	43.1	2240	0.554	0.139	200	3.2	5
1x50/16 KON		8.9	11	32.9	3.5	44.3	46.8	44.8	2516	0.386	0.151	245	3.2	7.2
1x70/16 KON		10.6	11	34.6	3.5	45.9	48.4	46.4	2807	0.272	0.165	305	3.2	10
1x95/16 KON		12.6	11	36.6	3.5	47.9	50.4	48.4	3107	0.206	0.181	360	3.2	13.6
1x95/35 KON	20157142	12.6	11	36.6	3.5	48.5	51	49	3469	0.206	0.181	355	7	13.6
1x120/16 KON		14.8	10.5	37.8	3.5	49.1	51.6	49.6	3430	0.161	0.205	425	3.2	17.2
1x150/25 KON		15.9	10.5	38.9	3.5	50.5	54	51	3818	0.129	0.215	475	5	21.5
1x185/25 KON		17.7	10.5	40.6	4	53.2	56.7	53.7	4363	0.106	0.229	530	5	26.5
1x240/25 KON	20313341	20.3	10	42.3	4	54.8	58.3	55.3	4915	0.0801	0.26	657	5	34.3
1x300/25 KON	20213350	22.7	10	44.7	4	57.2	60.7	57.7	5599	0.0641	0.28	710	5	42.9
1x400/35 KON	20213351	25.5	10	47.5	4.5	61	64.5	61.5	6740	0.0486	0.304	795	7	57.2
1x500/35 KON	20213354	29.5	10	51.5	4.5	65	68.5	65.5	7902	0.0384	0.339	905	7	71.5
1x630/35 KON	20213355	33.5	10	55.5	4.5	69	72.5	69.5	9659	0.0287	0.372	1035	7	90.1
1x630/50 KON	20226373	33.5	10	55.5	4.5	69	72.5	69.5	9713	0.0287	0.372	1035	10	90.1
1x800/35 KON		39.2	10	61.2	4.5	74.9	78.4	75.4	11950	0.0221	0.421	1170	7	114.4

(1) Permanent operation with DC or AC with 50 up to 60 Hz at 30 °C ambient temperature, free in air 30°C – phase to phase – distance: 2xD.



# Additional services/ product range

# PRY-CAM™ Grids

## Fixed monitoring system for increased wind farm reliability

Wind turbines are key strategic assets, and so, any power outages can cause a significant reduction in profitability and return on investment, and unplanned additional high costs for reactive maintenance.

Today wind farm reliability can be increased with Prysmian's innovative fixed monitoring systems for Partial Discharge (PD) and temperature measurement.

PRY-CAM™ Grids are integrated, autonomous PD monitoring systems for electric components, based on exclusive Prysmian PRY-CAM-sensing technology.

They allow the monitoring of conditions of medium-voltage components of a wind turbine by continuously tracking PD activity and local temperatures.

PD measurements are effectively used to predict and prevent faults on medium- and high-voltage electrical systems and components, such as transformers, generators, cables, joints, etc.

Thanks to Prysmian's exclusive sensing technology, the system is easy to install – even during wind turbine operation – without service interruption.

The system performs periodic measurements that are locally analysed, stored and sent to a remote server. Thanks to an exclusive algorithm, background and inverter noise is automatically identified and rejected in order to maintain the highest levels of PD-diagnosis accuracy.

All the information can be shared and/or integrated with any kind of existing monitoring system (SCAM for example) or asset management software.

In addition, measurements can be remotely viewed and controlled from any location via an Internet connection thanks to the Prysmian Web Infrastructure.



### Main benefits for customers

- Ideal for preventing failures and the associated costs of critical component replacement.
- Suitable for PD and temperature monitoring.
- Easy and quick installation – even during wind turbine operation.
- Maximum safety for operators thanks to galvanic isolation of equipment undergoing testing.
- Online measurements without wind turbine outage.
- Advanced alarming algorithms based on the complete PD pattern.
- Maximum flexibility to monitor several components with one device (e.g. cables, transformers, generators, etc.).

### Product features

- High-resolution acquisition of entire PD pulse waveforms, providing enhanced diagnostic capabilities.
- Robust noise-filtering and advanced-alarming algorithms available.
- Innovative sensors able to remotely detect small PD pulses.
- PD synchronisation does not require additional sensors (i.e. no need of CTs, Rogowski coils or capacitive couplers).
- Local storage and automatic processing of acquired data intuitive control software for live acquisition and data post-processing.
- Web-based interface for monitoring control.

# Offshore wind farms

## Linking the power of nature with future energy demands

Renewable energy resources are abundant and inexhaustible. They have the potential to meet global energy needs while reducing emissions and mitigating climate change.

Offshore wind applications are fundamental in meeting this increasing demand for greener energy.

As a world leader in this area, Prysmian Group has a long-standing track record of offering our customers proven, cost-effective cable designs and operating systems.

We're committed to investing in new and upgraded manufacturing and installation assets. We do this so we can offer the broadest possible range of innovative products and technologies, strengthening our services and capabilities in production and project execution for the offshore wind market.

As a trusted and dedicated partner we continue to support the needs of this growing industry, offering medium voltage inter-array cables, High-Voltage Alternating Current (HVAC) and High-Voltage Direct Current (HVDC) export cables.

As well as supply and turnkey solutions, we also offer monitoring and maintenance services. And we've developed a wide range of tailor-made accessories to meet even the most demanding customer requirements.

### Inter-array cable systems

We offer the full range of inter-array cables and with a comprehensive portfolio of supply and installation services. We undertake fully project managed turnkey projects with a complete EPCI approach, offering our customers an unparalleled service with the benefits of efficient and cost optimised solutions.

We lead the way in technological development, being the first to market with 66 kV inter-array cable systems under a Carbon Trust program in UK, meeting the requirements of offshore wind park developers and enabling reductions of up to 15% in capital expenditure for their projects.

In other fields, our systems specifically designed and constructed for use with non-anchored wind turbines in deeper waters, using our rigorously tested dynamic cables, which have an enhanced ability to withstand mechanical fatigue over the entire expected life of a system, are changing the game for wind farm development.

In short, we provide the means to ensure the future sustainable and reliable supply of renewable energy to consumers today.

### High voltage grid access

Prysmian high voltage submarine AC and DC cables form an integral part of power grids across the globe, including the links from offshore installations known as export cable systems.

We deliver a comprehensive and fully managed EPCI service to provide cable system solutions and services, considering innovative approaches and utilising our extensive engineering, manufacturing, and turnkey installation capabilities, with complete project management, to provide the necessary cost effective high power cable connections from offshore platforms and islands to national grid networks.

Thanks to the high reliability of our solutions for high voltage networks, we continue to forge ahead in the sector, maintaining long and successful relationships with our valued customers.

Prysmian not only offer the export cable systems, which today typically operate up to 220 kV AC and 320 kV DC respectively, but continue to develop and prove our product range to the highest voltage levels.

With our end-to-end service, utilising our range of manufacturing, installation and engineering assets, we are a single source provider offering full EPCI turnkey cable system solutions to meet our customer requirements

Our full value chain sets us apart, giving our customers a hassle-free single point of contact for all their project needs.

### Specialties

Prysmian designs tailor-made specialty solutions for a wide range of application fields.

Among the specialties designed for the offshore wind farm segment is Feltoflex HV cable system for moveable inter-connection between platforms (e.g. topside and bridge), developed for voltages of up to and including 155 kV, and featuring enhanced technical and installation characteristics including the use of the Group's technology range of Click-Fit® joints and connectors for easy and fast installation.

Prysmian has also a product portfolio of high temperatures cables, called SINOTHERM. They are suitable for installation in the nacelle up to temperatures of 110°C or 180°C.

# A track record of success

Our track record in the renewable energy sector includes projects working alongside some of the best-know names in the sector, including many ground-breaking industry milestones.

## Our customers

- Vestas
- Siemens
- Enercon
- Senvion
- Suzlon
- Gamesa
- Acciona
- Nordex
- Alstom
- Guodian
- Minyang
- Envision
- Sinovel
- Goldwind
- GE Wind
- EDF
- Enel-Endesa
- RWE
- Western Power
- E.ON
- SEAS
- DONG Energy
- Vattenfall
- Tennet Offshore
- Fluor

## Our key projects in Europe

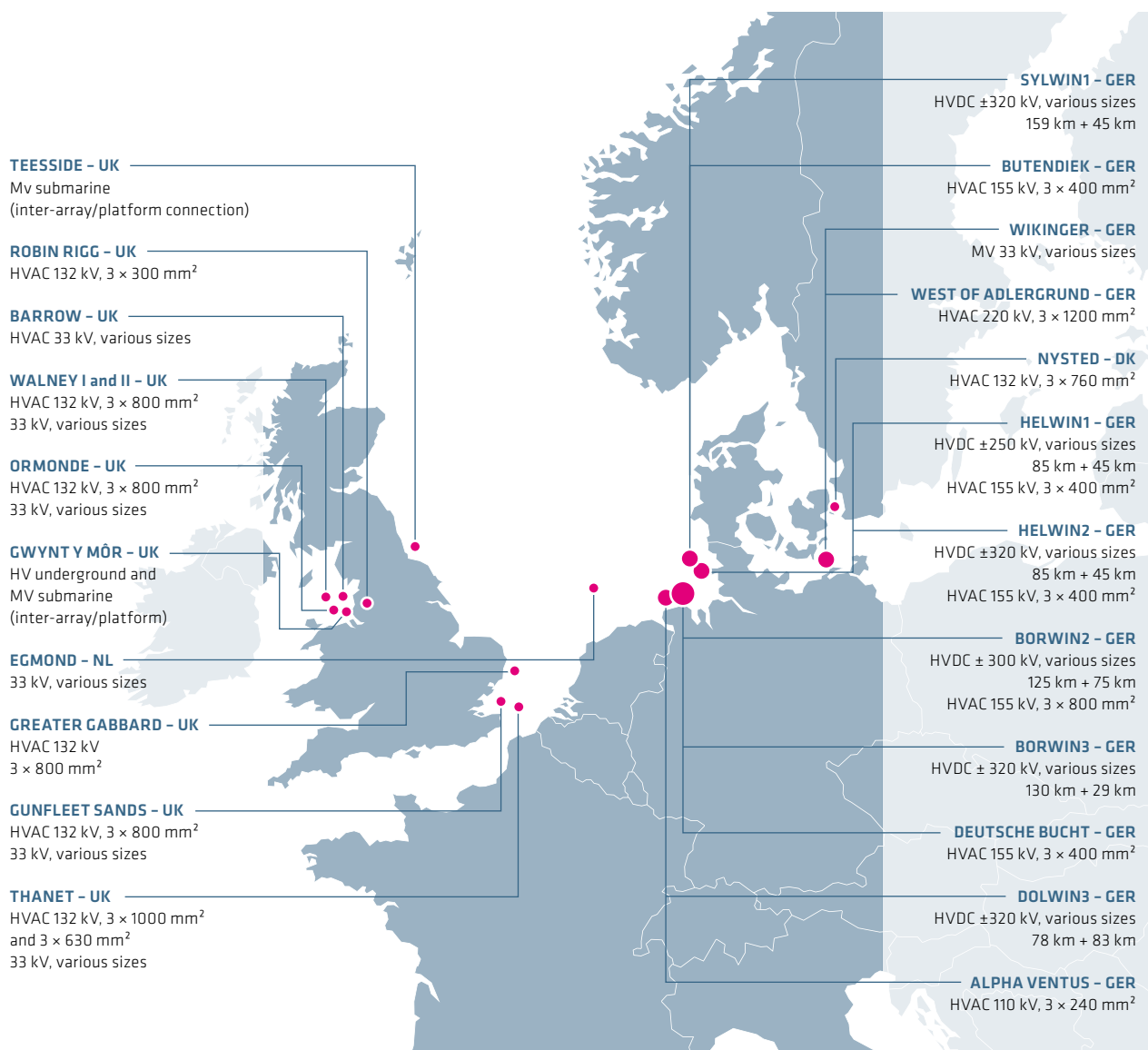

# Technical annex



# Fire testing methods

Flame retardance of a single cable is tested in accordance with IEC 60332-1. It is performed on a 60 cm cable sample with a gas flame for 1-4 min. depending on the cable diameter. The cable has to be self-extinguishing within certain limits to fulfil the test. Please see figure 1.

Fire retardance is tested on bunched cables in accordance with IEC 60332-3, simulating the fire behaviour of the cables installed in a bunch. The main category that is used is A. This is based on an amount of 7 litres of combustible material per metre.

The bunch of cables has to be minimum 3.5 m high when it is in a burning chamber subjected to fire from a burner directed at the cables for forty minutes. The cable bunch may not burn more than 2.5 m above the burner. Please see figure 2.

Smoke density is tested according to IEC 61034-1 (apparatus) and IEC 61034-2 (procedure and requirements). It is done by placing cable in a "smoke cube" (3x3x3 m). When the cable is burning, the light transmittance is measured using a photometric system. This test is aimed at simulating visibility when cables are burning on board a ship 60 % (70% for a single cable) visibility is satisfactory if it is attained throughout the test.

## Halogens

To test whether a material is halogen free or not, the tests IEC 60754-1 and 60754-2 are used. The acidity of the gases from burning materials is measured. Being halogen-free means that the materials used in the cables do not contain any halogens – such as chlorine, bromine, iodine and fluorine. In order to attain the self-extinguishing effects that halogens have in cables, ATH based materials are used alternatively. The negative effects of halogens (corrosivity, toxicity etc.) are avoided.

### Vertical flame propagation test

#### IEC 60332-1

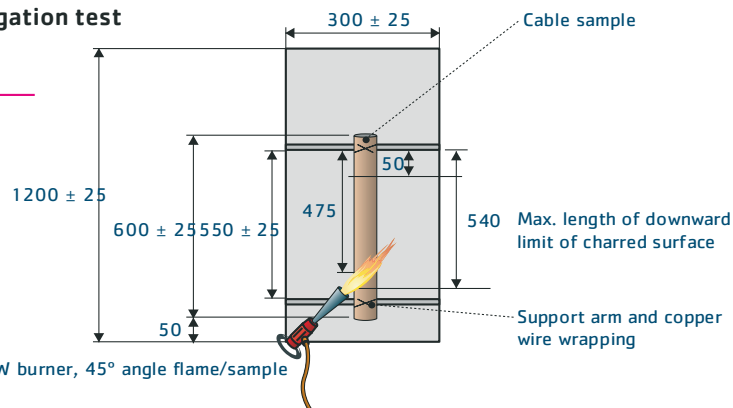

Figure 1.

1 kW burner, 45° angle flame/sample

### Vertical flame spread of bunched cables

#### IEC 60332-3-22 /-24 (Cat. C)

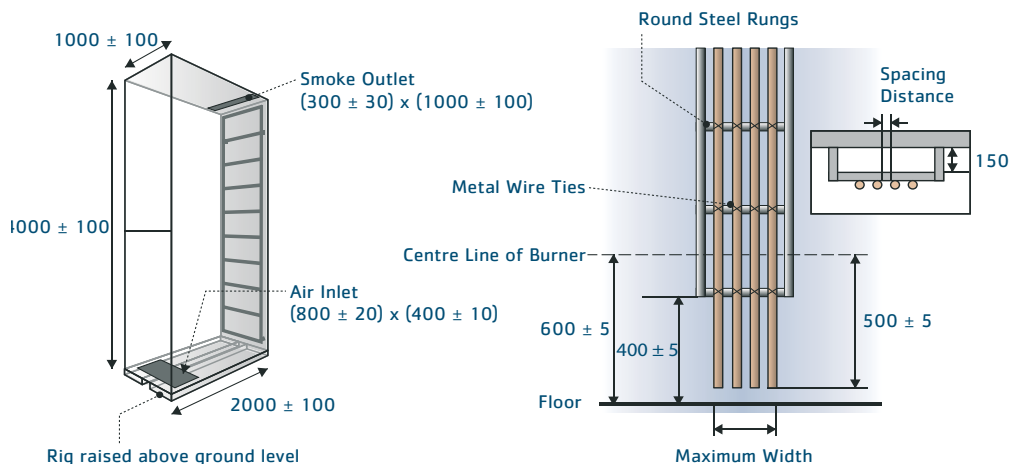

Figure 2.

# Conductors

Voltage drop for DC power supply and single phase systems at 20°C					
Nominal cross section	Class 1 & class 2			Class 5 & class 6	
	Annealed copper conductor		Conductor of aluminium or aluminium alloy	Annealed copper conductor	
	Plain wires	Metal coated wires		Plain wires	Metal coated wires
mm <sup>2</sup>	V/(A x km)				
0.5	72.0	73.4	-	78.0	80.2
0.75	49.0	49.6	-	52.0	53.4
1	36.2	36.4	-	39.0	40.0
1.5	24.2	24.4	-	26.6	27.4
2.5	14.82	15.12	-	15.96	16.42
4	9.22	9.40	-	9.90	10.18
6	6.16	6.22	-	6.60	6.78
10	3.660	3.680	6.160	3.820	3.900
16	2.300	2.320	3.308	2.420	2.480
25	1.454	1.468	2.078	1.568	1.590
35	1.048	1.058	1.503	1.108	1.130
50	0.774	0.782	1.110	0.772	0.786
70	0.536	0.540	0.767	0.544	0.554
95	0.386	0.390	0.554	0.412	0.420
120	0.306	0.308	0.438	0.322	0.328
150	0.248	0.252	0.357	0.258	0.264
185	0.198	0.200	0.284	0.212	0.216
240	0.151	0.152	0.217	0.160	0.163

Voltage drop for 3-phase systems at 20°C					
Nominal cross section	Class 1 & class 2			Class 5 & class 6	
	Annealed copper conductor		Conductor of aluminium or aluminium alloy	Annealed copper conductor	
	Plain wires	Metal coated wires		Plain wires	Metal coated wires
mm <sup>2</sup>	V/(A x km)				
0.5	62.35	63.57	-	67.55	69.46
0.75	42.44	42.95	-	45.03	46.25
1	31.35	31.52	-	33.77	34.64
1.5	20.96	21.13	-	23.04	23.73
2.5	12.83	13.09	-	13.82	14.22
4	7.98	8.14	-	8.57	8.82
6	5.33	5.39	-	5.72	5.87
10	3.17	3.19	5.33	3.31	3.38
16	1.992	2.009	3.308	2.096	2.148
25	1.259	1.271	2.078	1.358	1.377
35	0.908	0.916	1.503	0.960	0.979
50	0.670	0.677	1.110	0.669	0.681
70	0.4642	0.4677	0.7673	0.4711	0.4798
95	0.3343	0.3377	0.5543	0.3568	0.3637
120	0.2650	0.2667	0.4382	0.2789	0.2841
150	0.2148	0.2182	0.3568	0.2234	0.2286
185	0.1716	0.1732	0.2841	0.1836	0.1871
240	0.1306	0.1320	0.2165	0.1387	0.1415

# Electrical parameters

## Voltages

For the rated, operating and test voltages of cables, the definitions given in DIN VDE 0298, Part 3, apply. Some of these are mentioned in the table below.

AC = Alternating Current

DC = Direct Current

## Rated voltage

The rated voltage of an insulated electric cable is the voltage which is used as the basis for the design and the testing of the cable with regard to its electrical characteristics.

The rated voltage is expressed by the two values of power frequency voltage  $U_0/U$  in V.

$U_0$  = rms value between one conductor and "earth"

$U$  = rms value between two conductors of a multi-core cable or of a system of single-core cables

In a system with AC voltage, the rated voltage of a cable must be at least equal to the rated voltage of the system for which it is used. This requirement applies both to the value  $U_0$  and the value  $U$ .

In a system with DC voltage, its rated voltage must not be more than 1.5 times the value of the rated voltage of the cable.

## Operating voltage

The operating voltage is the voltage applied between the conductors and earth of a power installation with respect to time and place with trouble-free operation.

### • Cables with a rated voltage $U_0/U$ up to 0.6/1 kV

These cables are suitable for use in three-phase AC, single-phase AC and DC installations.

The maximum continuously permissible operating voltage of which does not exceed the rated voltage of the cables by more than:

- 10% for cables with a rated voltage  $U_0/U$  up to and including 450/750 V.
- 20% for cables with a rated voltage  $U_0/U = 0.6/1$  kV.

### • Cables with a rated voltage $U_0/U$ greater than 0.6/1 kV

These cables are suitable for use in three-phase and single-phase AC installations.

The maximum operating voltage of which does not exceed the rated voltage of the cable by more than 20%.

### • Cables in DC installations

If the cables are used in DC installations, the continuously permissible DC operating voltage between the conductors must not exceed 1.5 times the value of the permissible AC operating voltage.

In single-phase earthed DC installations this value should be multiplied by a factor of 0.5.

## Test voltage

Regarding the test voltage of flexible cables, the values given in the corresponding parts of cable standard apply.

If the relevant shield is missing, as for example with OZOFLEX(PLUS) and HYDROFIRM cables, "core against core" is tested in appropriate combinations. The values are to be regarded as AC test voltages (unless stated otherwise) for single-phase testing, i.e. the AC test voltage is applied between the core and the corresponding shielding (e.g. semi-conductive layer, earth conductor, shield).

Telecommunication cores (pairs) and other shielded pairs (e.g. (2x1)C) are tested "core against core" and "core against shield" whereby the test voltages are correspondingly different. With single-core cables without shielding, the corresponding opposite pole is a water bath.

Allocation of cable rated voltages to the highest voltages of a system, test voltage and test duration

Cable rated voltage $U_0/U$	Max. permitted operating voltage of a system for				Test voltage		Test duration minimum
	AC	Three-phase current	DC	DC	AC	DC	
	Line - Earth	Line - Line	Line - Earth	Line - Line			
V	V	V	V	V	kV	kV	min
100/100	110	110	165	165	1	-	15
230/400	254	440	330	660	2	-	5
300/300	-	-	-	-	2	-	15
300/500	318	550	413	825	2	-	15
450/750	476	825	619	1238	2.5	-	15
kV	kV	kV	kV	kV	kV	kV	min
0.6/1	0.7	1.2	0.9	1.8	2.5	-	5
1.8/3	2.1	3.6	2.7	5.4	6.0	-	-
3.6/6	4.2	7.2	5.4	10.8	11.0	27.5	-
6/10	6.9	12	9	18	17.0	42.5	-
8.7/15	10.4	18	13.5	27	24.0	60.0	-
12/20	13.9	24	18	36	29.0	72.5	-
14/25	17.3	30	22.5	45	36.0	90.0	-
18/30	20.8	36	27	54	43.0	107.5	-
20/35	24.2	42	31	63	50.0	125.0	-

Permissible short-circuit current at max. permissible short-circuit temperatures of the conductor surface and for a fault duration  $t_{kr} = 1$  s

# Drum handling

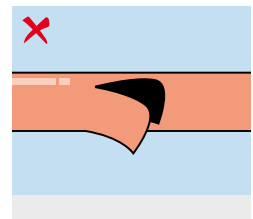
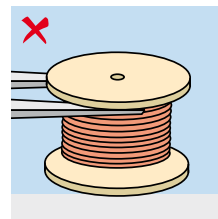
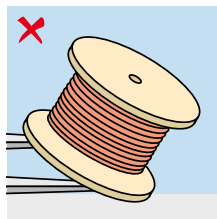
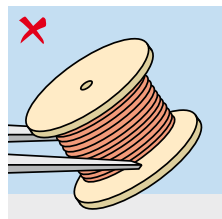
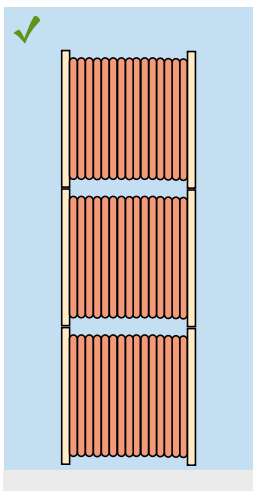
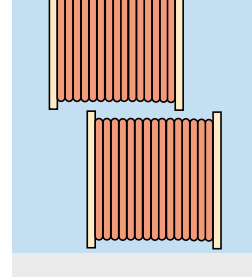
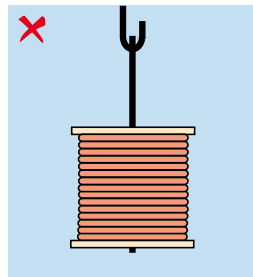
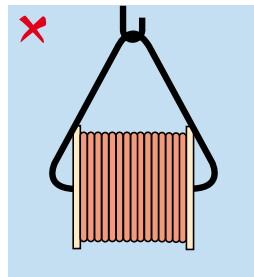
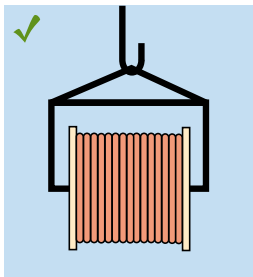
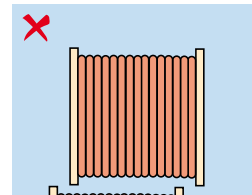
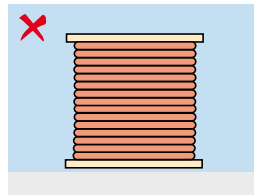
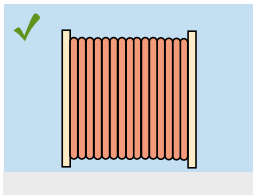

Do not attempt to lift drums of cable without inserting the fork lift tynes fully under both flanges as the tynes can damage the cable, making it unserviceable. Do not attempt to lift drums by the flange or to lift drums into the upright (correct) position by lifting the top flanges as it may break the flange from the drum barrel. The drum will then be undeliverable. Use a length of steel pipe through the centre of the drum to provide leverage and control.

This cable has been rendered unserviceable through fork lift tine damage and may necessitate the scrapping of the whole drum.

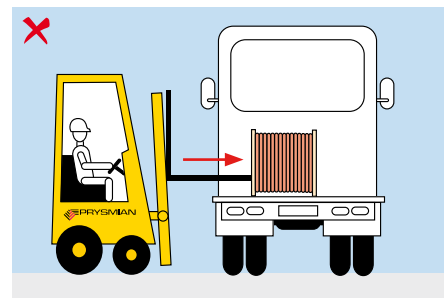
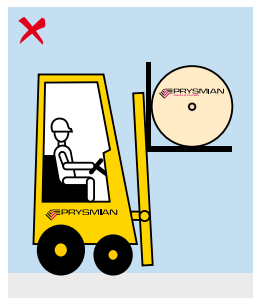
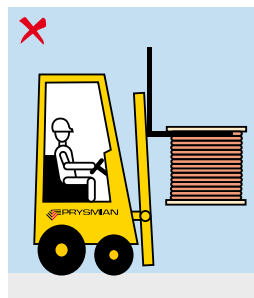
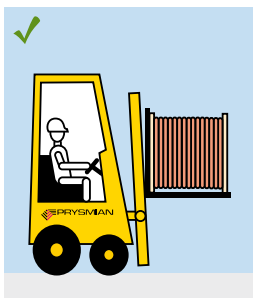

Do not use the fork lift tynes to push cable drums sideways on a truck tray or the ground as damage to the flanges can result in the drum being unacceptable to customers.

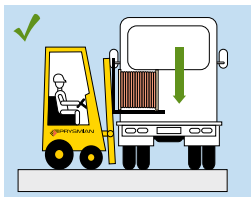

Lower drums gently onto the ground or transport.

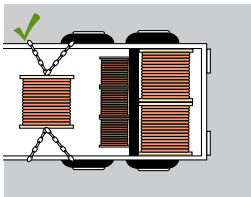

Always protect cable from rubbing or damage. Adjust load or use separators.

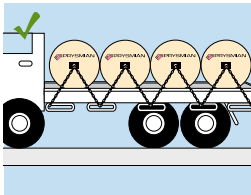

Heavy drums should be chained appropriately for transit, with protection from the chain rubbers for the spindle hole in the centre of the drum. Under no circumstances are drums to be transported on their side.

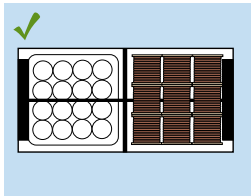

Always protect product, especially spools, against rope damage during tying down of load.

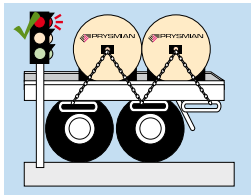

Ensure drums are restrained to restrict movement during sudden stop/starts.

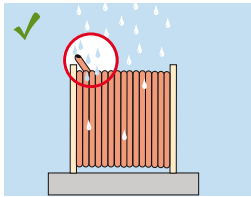

Ensure cable sealing is intact so moisture cannot seep into cable. Report damage.

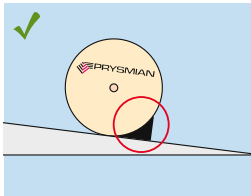

When placing drums on an uneven surface be prepared to chock drums to prevent rolling if required.

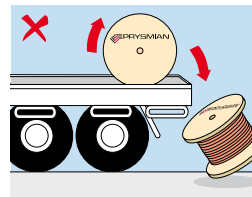

Avoid impact force loadings. Never drop drums.

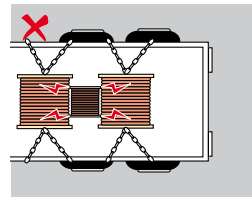

Never let drum flanges contact cable on adjacent drums.

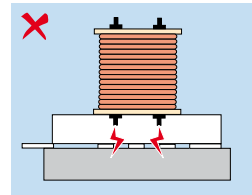

Never lay drums on their side, even on top of pallets, as protruding bolts damage spools and cable.

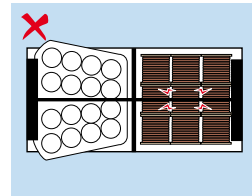

Never use rope directly over shrink-wrapped cable.

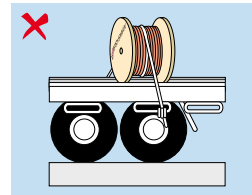

When securing drums for transit, do not place ropes or chains over cable as damage can occur to the outer insulation rendering the cable unserviceable.

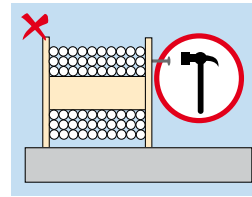

Avoid use of additional nails on drums or cable, because flange thickness vary.

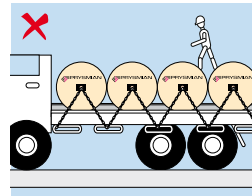

Never climb or walk over products loaded on the truck. If you must get onto the tray, do not go higher than the deck height.

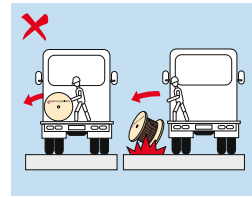

Do not roll cable drums from the back of a delivery truck to the ground as with the resulting flange damage the cable will not be able to be rolled off the drum.

## Storage recommendations

When storing cable drums for long periods, please take the following guidelines into consideration:

- Select a site for storage that is level and dry, preferably indoors with a concrete surface, with no risk of falling objects, chemical spills (oil, grease, etc.) open flames and excessive heat (see fig. 1).
- If concrete hard storage is not available, select a well-drained surface that will prevent the reel flanges sinking into it (see fig. 1).
- The drums must always be stored with their flanges vertical.
- Leave enough space between stored drums for air circulation (see fig. 2).
- If drums are stored in a high traffic area (fork lifts frequent transit) suitable barriers should be erected to prevent damage from moving equipment (see fig. 2).
- The bolts should be tightened at regular intervals.
- During storage, the drums should be rolled to an angle of 90°C every three months (see fig. 3).
- When only a portion of the cable is used, the open end of the cable remaining on the drum should immediately be re-sealed to prevent the entrance of moisture. Once it has been re-sealed, the cut end should be fixed to the inside edge of the drum flange to prevent the end from extending beyond the flanges during drum movement.
- When it is required to rewind the cable on to another drum, always consider that the diameter of the new drum barrel should be at least the same size of the original drum barrel diameter (see fig. 4).

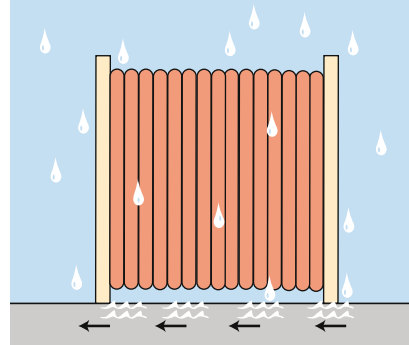

Fig. 1

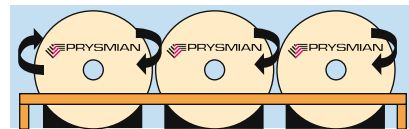

Fig. 2

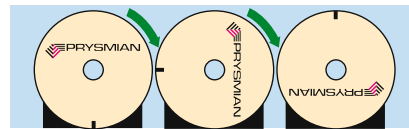

Fig. 3

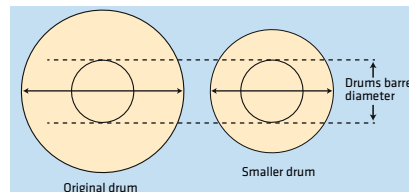

Fig. 4









## Linking the future

Issue: September 2018

All sizes and values without tolerances are reference values. Specifications are for product as supplied by Prysmian Group: any modification or alteration afterwards of product may give different result. The content contained within this document must not be copied, reprinted or reproduced in any form, either wholly or in part, without the written consent of Prysmian Group. The information is believed to be correct at the time of issue. Prysmian Group reserves the right to amend this specification without prior notice. This specification is not contractually valid unless specifically authorised by Prysmian Group.